



Serial Console Server

SN0108A / SN0116A / SN0132 / SN0148 / SN9108 / SN9116

User Manual



EMC Information

FEDERAL COMMUNICATIONS COMMISSION INTERFERENCE STATEMENT: This equipment has been tested and found to comply with the limits for a Class A digital device, pursuant to Part 15 of the FCC Rules. These limits are designed to provide reasonable protection against harmful interference when the equipment is operated in a commercial environment. This equipment generates, uses, and can radiate radio frequency energy and, if not installed and used in accordance with the instruction manual, may cause harmful interference to radio communications. Operation of this equipment in a residential area is likely to cause harmful interference in which case the user will be required to correct the interference at his own expense.

This device complies with Part 15 of the FCC Rules. Operation is subject to the following two conditions: (1) this device must not cause harmful interference, and (2) this device must accept any interference received, including interference that may cause undesired operation.

FCC Caution: Any changes or modifications not expressly approved by the party responsible for compliance could void the user's authority to operate this equipment.

CE Warning: This is a class A product. In a domestic environment this product may cause radio interference in which case the user may be required to take adequate measures.

KCC Statement: 유선 제품용 / A 급 기기 (업무용 방송 통신 기기)
이 기기는 업무용 (A 급) 전자파적합기기로서 판매자 또는 사용자는 이 점을 주의하시기 바라며 , 가정 외의 지역에서 사용하는 것을 목적으로 합니다 .

Suggestion: Shielded twisted pair (STP) cables must be used with the unit to ensure compliance with FCC & CE standards.

RoHS

This product is RoHS compliant.



SJ/T 11364-2006

The following contains information that relates to China.

部件名称	有毒有害物质或元素					
	铅	汞	镉	六价铬	多溴联苯	多溴二苯醚
电器部件	●	○	○	○	○	○
机构部件	○	○	○	○	○	○

- : 表示该有毒有害物质在该部件所有均质材料中的含量均在SJ/T 11363-2006规定的限量要求之下。
- : 表示符合欧盟的豁免条款, 但该有毒有害物质至少在该部件的某一均质材料中的含量超出SJ/T 11363-2006的限量要求。
- ×: 表示该有毒有害物质至少在该部件的某一均质材料中的含量超出SJ/T 11363-2006的限量要求。

Battery Safety Notice



- ◆ There is a risk of explosion if the battery is replaced with an incorrect type. Dispose of used batteries according to the relevant instructions.

Batterie avis de sécurité



- ◆ Il existe un risque d'explosion si la batterie est remplacée par un incorrect tapez. Jeter les piles usagées selon la pertinente instructions.

User Information

Online Registration

Be sure to register your product at our online support center:

International	http://eservice.aten.com
---------------	---

Telephone Support

For telephone support, call this number:

International	886-2-8692-6959
China	86-10-5255-0110
Japan	81-3-5615-5811
Korea	82-2-467-6789
North America	1-888-999-ATEN ext 4988
United Kingdom	44-8-4481-58923

User Notice

All information, documentation, and specifications contained in this manual are subject to change without prior notification by the manufacturer. The manufacturer makes no representations or warranties, either expressed or implied, with respect to the contents hereof and specifically disclaims any warranties as to merchantability or fitness for any particular purpose. Any of the manufacturer's software described in this manual is sold or licensed *as is*. Should the programs prove defective following their purchase, the buyer (and not the manufacturer, its distributor, or its dealer), assumes the entire cost of all necessary servicing, repair and any incidental or consequential damages resulting from any defect in the software.

The manufacturer of this system is not responsible for any radio and/or TV interference caused by unauthorized modifications to this device. It is the responsibility of the user to correct such interference.

The manufacturer is not responsible for any damage incurred in the operation of this system if the correct operational voltage setting was not selected prior to operation. PLEASE VERIFY THAT THE VOLTAGE SETTING IS CORRECT BEFORE USE.

Package Contents

The Serial Console Server package consists of:

SN0108A / SN0116A

- 1 SN0108A / SN0116A Serial Console Server
- 1 SA0142 Serial Adapters (RJ45-F to DB9-M; DTE to DCE)
- 1 SA0141 Serial Adapter (RJ45-F to DB9-F; DTE to DTE)
- 1 CD-ROM with management software and Real COM drivers
- 1 Laptop USB Console Cable
- 2 Power Cords (AC models)
- 1 Rack Mount Kit
- 2 Lok-U-Plugs
- 1 User Instructions*

SN0132 / SN0148

- 1 SN0132 / SN0148 Serial Console Server
- 1 SA0142 Serial Adapters (RJ45-F to DB9-M; DTE to DCE)
- 1 SA0141 Serial Adapter (RJ45-F to DB9-F; DTE to DTE)
- 1 SA0150 Serial Adapter (RJ45-F to DB9-M; PN0108 PON IN)
- 1 Laptop USB Console Cable
- 2 Power Cords (AC models)
- 1 Rack Mount Kit
- 1 Foot Pad Set (4 pcs.)
- 1 User Instructions*

SN9108 / SN9116

- 1 SN9108 / SN9116 Serial Console Server
- 1 CD-ROM with management software and Real COM drivers
- 1 Power Cords (AC models)
- 1 Rack Mount Kit
- 1 Lok-U-Plugs
- 1 User Instructions*

Check to make sure that all of the components are present and in good order. If anything is missing, or was damaged in shipping, contact your dealer.

Read this manual thoroughly and follow the installation and operation procedures carefully to prevent any damage to the Serial Console Server or to any other devices on the installation.

* Features may have been added since this manual was published. Please visit our website to download the most up-to-date version of the manual.

Copyright © 2015 ATEN® International Co., Ltd.
Manual Date: 2015-09-23

Altusen and the Altusen logo are registered trademarks of ATEN International Co., Ltd. All rights reserved.
All other brand names and trademarks are the registered property of their respective owners.

Contents

EMC Information	ii
SJ/T 11364-2006	iii
Battery Safety Notice	iii
Batterie avis de sécurité	iii
User Information	iv
Online Registration	iv
Telephone Support	iv
User Notice	iv
Package Contents	v
SN0108A / SN0116A	v
SN0132 / SN0148	v
SN9108 / SN9116	vi
About This Manual	xii
Overview	xii
Conventions	xiii
Terminology	xiv
Product Information	xiv

Chapter 1.

Introduction

Overview	1
Features	3
System Accessibility and Availability	3
Serial Console Management	3
Security	4
System Management	4
Serial Device Management	5
Language	5
Requirements	6
RJ-45 to Serial Adapters	7
RJ-45 to RJ-45 Cat 5e Cables	7
Browsers	8
Components	9
SN0108A Front View	9
SN0116A Front View	9
SN0132 Front View	11
SN0148 Front View	11
SN9108 Front View	13
SN9116 Front View	13
SN0108A Rear View	15
SN0116A Rear View	15
SN0132 Rear View (AC Power)	16
SN0148 Rear View (AC Power)	16
SN0132 Rear View (DC Power)	17

SN0148 Rear View (DC Power)	17
SN9108 Rear View	18
SN9116 Rear View	18

Chapter 2.

Hardware Setup

Before You Begin	19
Stacking and Rack Mounting	19
Stacking	19
Rack Mounting	21
Serial Console Server Installation	25
SN0108A / SN0116A / SN0132 / SN0148 Installation	25
SN9108 / SN9116 Installation	28

Chapter 3.

Super Administrator Setup

Overview	31
First Time Setup	31
Local Login	31
Remote Login	34
Setup	36
Network Setup	36
Changing the Super Administrator Login	37

Chapter 4.

The User Interface

Access	39
Local Console Operation	40
Remote Operation	41
Web Browser Login	41
The Web Browser Main Page	42
Page Components	42
The Tab Bar	44
SNViewer	45
Control Panel Functions	46
Data Import	47
Encode	48
The Message Board	48
Macros	49
Terminal Settings	50
Terminal Application	52

Chapter 5.

Port Operating Modes

Overview	53
Work Mode	54
Console Management	54

Virtual Modem	54
Real COM Port	54
TCP Server / TCP Client	55
UDP Mode	56
Serial Tunnel	56

Chapter 6.

Port Access

Overview	57
The Sidebar	58
The Sidebar Tree Structure	58
Filter	59
Connections	60
Telnet/SSH	61
Port Attributes	62
Favorites	63
History	63
Preferences	64
Sessions	66
Access	67
Properties	69
Port Buffering	71
Operating Mode	72

Chapter 7.

User Management

Overview	75
Users	76
Adding Users	76
Modifying User Accounts	79
Deleting User Accounts	79
Groups	80
Creating Groups	80
Modifying Groups	82
Deleting Groups	82
Users and Groups	83
Assigning Users to a Group From the User's Notebook	83
Removing Users From a Group From the User's Notebook	84
Assigning Users to a Group From the Group's Notebook	85
Removing Users From a Group From the Group's Notebook	86
Device Assignment	87
Assigning Device Permissions From the User's Notebook	87
Assigning Device Permissions From the Groups' Notebook	89

Chapter 8.

Device Management

Devices	91
-------------------	----

Network	93
ANMS	98
OOBC	106
Security	109
Association	113
Date/Time	116

Chapter 9.

Log

Overview	119
System Log	119
Filter	120
Log Notification Settings	122

Chapter 10.

Maintenance

Overview	123
Backup / Restore	123
Backup	124
Restore	124
Firmware Upgrade	125
Certificates	126

Appendix

Safety Instructions	131
General	131
Rack Mounting	133
Technical Support	134
International	134
North America	134
Specifications	135
SN0108A / SN0116A	135
SN0132 / SN0148	136
SN0132D / SN0148D	137
SN9108 / SN9116	138
IP Address Determination	139
The Local Console	139
IP Installer	139
Browser	140
IPv6	141
Link Local IPv6 Address	141
IPv6 Stateless Autoconfiguration	142
Virtual Modem Details	143
AT Command Set Support	143
Port Forwarding	145
Clear Login Information	146
RJ-45 to Serial Adapters	147

Limited Warranty 151

About This Manual

This User Manual is provided to help you get the most from your Serial Console Server system. It covers all aspects of installation, configuration and operation. An overview of the information found in the manual is provided below.

Overview

Chapter 1, *Introduction*, introduces you to the Serial Console Server. Its purpose, features and benefits are presented, and its front and back panel components are described.

Chapter 2, *Hardware Setup*, provides step-by-step instructions for setting up your installation, and explains some basic operation procedures.

Chapter 3, *Super Administrator Setup*, explains the procedures that the super administrator employs to set up the Serial Console Server network environment, and change the default username and password.

Chapter 4, *The User Interface*, describes the layout and explains the components of the Serial Console Server user interface. Describes how to log in to the Serial Console Server with each of the available access methods: from a local console; an Internet browser; and Windows application (AP) programs.

Chapter 5, *Port Operating Modes*, describes the port operating modes, which include Virtual Modem, Serial Tunnel, Console Management, and Real COM Port modes.

Chapter 6, *Port Access*, describes the Port Access page and how to configure the options it provides regarding port and power outlet manipulation.

Chapter 7, *User Management*, shows super administrators and administrators how to create, modify, and delete users and groups, and assign attributes to them.

Chapter 8, *Device Management*, shows super administrators how to configure and control overall Serial Console Server operations.

Chapter 9, *Log*, explains how to install and configure the Log Server.

Chapter 10, *Maintenance*, explains how to backup, restore, and upgrade the Serial Console Server and its firmware, as well as providing information about private certificates.

An Appendix, at the end of the manual provides technical and troubleshooting information.

Conventions

This manual uses the following conventions:

- | | |
|---|--|
| Monospaced | Indicates text that you should key in. |
| [] | Indicates keys you should press. For example, [Enter] means to press the Enter key. If keys need to be chorded, they appear together in the same bracket with a plus sign between them: [Ctrl+Alt]. |
| 1. | Numbered lists represent procedures with sequential steps. |
| ◆ | Bullet lists provide information, but do not involve sequential steps. |
| → | Indicates selecting the option (on a menu or dialog box, for example), that comes next. For example, Start → Run means to open the <i>Start</i> menu, and then select <i>Run</i> . |
|  | Indicates critical information. |

Terminology

Throughout the manual we make reference to the terms *Local* and *Remote* in regard to the operators and equipment deployed in a Serial Console Server installation. Depending on the point of view, users and servers can be considered *Local* under some circumstances, and *Remote* under others:

- ◆ Serial Console Server's Point of View
 - ◆ Remote users – We refer to a user as a *Remote* user when we think of him as someone who logs into the Serial Console Server over the net from a location that is *remote from the* Serial Console Server.
 - ◆ Local Console – a computer connected directly to the Serial Console Server by a physical connection.
 - ◆ Servers, Serial Device, or Port Device– any device attached to the Serial Console Server's ports via cable.
- ◆ User's Point of View
 - ◆ Local client users – We refer to a user as a *Local user* when we think of him as sitting at his computer performing operations on the devices connected to the Serial Console Server that is *remote from him*.

When we describe the overall system architecture we are usually speaking from the Serial Console Server's point of view – in which case the users are considered remote. When we speak about operations users perform via the browser, viewers, and AP programs over the net, we are usually speaking from the user's point of view – in which case the Serial Console Server and the devices connected to it are considered remote.

Product Information

For information about all ALTUSEN products and how they can help you connect without limits, visit ALTUSEN on the Web or contact an ALTUSEN Authorized Reseller. Visit ALTUSEN on the Web for a list of locations and telephone numbers:

International	http://www.aten.com
North America	http://www.aten-usa.com

Chapter 1

Introduction

Overview

The Serial Console Server series of advanced console servers integrates cutting edge technologies with secure enterprise communications. Models offer IT professionals and network operations center (NOC) personnel the ability to perform secure, remote data management and out-of-band management of IT assets from anywhere in the world. Available in 8, 16, 32 and 48-port models, the console servers fit in 1U of rack space with dual AC and DC (SN0132D / SN0148D) power options. With their comprehensive serial management features, the console servers help maximize IT asset productivity, provide scalability and reduce operational costs.

Model	Ports	Power	LAN Ports	USB / LUC
SN0108A	8	Dual / AC	Dual	3 / 1
SN0116A	16	Dual / AC	Dual	3 / 1
SN0132	32	Dual / AC	Dual	3 / 1
SN0148	48	Dual / AC	Dual	3 / 1
SN0132D	32	Terminal / DC	Dual	3 / 1
SN0148D	48	Terminal / DC	Dual	3 / 1
SN9108	8	Single / AC	Single	None
SN9116	16	Single / AC	Single	None

The SN0108A / SN0116A / SN0132 / SN0148 / SN9108 / SN9116 are console servers that provide remote serial access to up to 8 (SN0108A / SN9108), 16 (SN0116A / SN9116), 32 (SN0132) or 48 (SN0148) servers or other serial IT devices (hubs, routers, power management devices, etc.), via a Telnet or SSH TCP/IP connection. Serial Console Server devices can work in tandem with other remote management products – such as ALTUSEN PN5/PN7 and PN0108 Power over the NET™ devices – to provide convenient, reliable, and effective, remote data center device management.

The SN0108A / SN0116A / SN0132 / SN0148 / SN9108 / SN9116 also offer software features to meet the most demanding data center management applications. Features include multilingual Web user interface (UI), versatile operation modes, Serial Viewer with a comprehensive set of functions, and

power management integration. This enables administrators to have complete control of remote serial devices to shorten mean-time-to-recover (MTTR). Furthermore, to comply with existing data center network access policies, the Serial Console Server provides customizable multiple access levels for secure management.

Providing a complete solution for secure remote control, the Serial Console Server also features 3rd party authentication, data encryption during transmission, access list, data logging, and event monitoring and notification. In addition, the console servers support next generation network standards such as Internet Protocol version 6 (IPv6).

Installation is fast and easy: plugging cables into their appropriate ports is all that is entailed. A choice of browser based GUI, Telnet (SSH), laptop USB console (SN0108A / SN0116A / SN0132 / SN0148) and VT console terminal sessions make configuration and operation smooth and convenient.

The SN0108A / SN0116A / SN0132 / SN0148 / SN9108 / SN9116's firmware is upgradeable, so you can stay current with the latest improvements simply by downloading updates from our website. With its advanced features and ease of operation, the Serial Console Server is the most convenient, most reliable, and most cost effective way to centrally manage your remote, serially connected, IT products.

Features

System Accessibility and Availability

- ◆ Remote serial access for up to 8/16/32/48 servers or other serial devices
- ◆ Secure in-band and out-of-band network access to serial consoles
- ◆ In-band access of Ethernet
- ◆ Browser access with an intuitive GUI
- ◆ Terminal-based access with a menu-driven UI
- ◆ Out-of-band access of dial-up modem
- ◆ Modem dial-in/dial-back/dial-out
- ◆ SN0108A / SN0116A / SN0132 / SN0148 Include:
 - ◆ Front access USB ports for USB storage or for USB-based PC cards
 - ◆ Laptop USB Console (LUC) port for extra local console access via laptop computer
 - ◆ Dual Ethernet ports for redundancy or for dual IP addresses access
 - ◆ Dual power supply

Serial Console Management

- ◆ Convenient and simple access via browser or Telnet/SSH client
- ◆ Port access via Telnet/SSH client and third-party client such as PuTTY
- ◆ Direct port access from Telnet client – bypassing login to SN
- ◆ Convenient port access via the applet serial viewer from SN Web GUI
- ◆ Selectable Telnet or SSH for the serial viewer
- ◆ Selectable ActiveX or Java for the serial viewer
- ◆ Comprehensive viewer function – copy/paste, logging, data import, Macro, broadcast and Message Board
- ◆ Sun Solaris ready – Sun “break-safe”
- ◆ Alert String
- ◆ Command filter
- ◆ Data buffering
- ◆ Multiple users simultaneously access to the same port – up to 16 connections per port
- ◆ Selectable mode for multiple simultaneous access – Exclusive/ Occupy/ Share mode

- ◆ Integrated with Power Over the NET™ products for port and power outlet association

Security

- ◆ SSH and SSL support
- ◆ Supports CA certificates
- ◆ Configurable user permissions for port access and control
- ◆ Configurable group permission for port access and control
- ◆ Local and remote authentication and logging
- ◆ Third-party authentication supports RADIUS, TACACS+, LDAP/AD, and Kerberos
- ◆ IP filtering and MAC filtering

System Management

- ◆ System configuration via Web browser of HTTP/HTTPS, Telnet/SSH client and local console
- ◆ Up to 64 user accounts – allow 64 concurrent logins to access the system
- ◆ System log and event logging
- ◆ Comprehensive logging and event notification
- ◆ ATEN Log server and Syslog server
- ◆ SNMP agent
- ◆ Event notification – supports notification of SMTP email, SNMP Trap, and SMS (with additional mobile device)
- ◆ Pure Web management interface (HTTP/HTTPS), no Java run-time environment required
- ◆ Backup/restore system configuration
- ◆ Firmware upgradeable
- ◆ Multi-browser support – Internet Explorer, Chrome, Firefox, Safari, Opera, Mozilla
- ◆ Customizable global time zone
- ◆ NTP for time server synchronization
- ◆ DHCP for dynamic IP address assignment
- ◆ IPv6 support
- ◆ Integrated with CC2000 for data center centralized management
- ◆ Supports AC or DC (SN0132D / SN0148D) operation

Serial Device Management

- ◆ Versatile serial operation modes – supports Real COM, TCP Server, TCP Client, UDP, Serial Tunnel and Virtual Modem
- ◆ 128-bit/256-bit SSL encryption for Real COM, TCP Server, TCP Client, Serial Tunnel and Virtual Modem
- ◆ Virtual Terminal support (VT52, VT100, VT220, VT320)
- ◆ Real COM driver for Windows 2000/XP/Vista/7 and Windows Server 2003/2008
- ◆ Built-in 15KV ESD protection for serial ports
- ◆ Real TTY driver for Linux
- ◆ Fixed TTY driver for UNIX

Language

- ◆ Multi-language web-based GUI – available for Japanese, Korean, German, Russian, Simplified Chinese and Traditional Chinese

Requirements

- ◆ The devices that connect to the Serial Console Server must support the following serial protocol:
 - ◆ RS-232 (protocol or terminal operations)
- ◆ For Console Management operating mode; Telnet/SSH client, a third party client such as PuTTY, or web browser must be installed
- ◆ For the browser-based WinClient ActiveX, SNViewer for console operating mode, and DirectX 8 must be present, and at least 2MB of memory must be available after installation.
- ◆ For the browser-based Java Applet Viewer SNViewer for console management operating mode, Sun's Java 2 JRE 1.4.2 or higher must be installed, and at least 2MB of memory must be available after installation. Java is available for free download from the Sun Java website:

`http://java.sun.com`
- ◆ The Virtual COM port driver (Real COM port) support requires Windows 2000 or higher.
- ◆ Under Vista (32-bit version), only the administrator can install the Virtual Port Management Utility – ordinary users can only operate the mapped Real COM ports.
- ◆ The current Linux TTY driver supports kernels 2.2, 2.4, 2.6 (up to 2.6.39), and 3.1 (up to 3.1.5-23).
- ◆ The Fixed TTY driver for UNIX supports: Unix, OpenServer; Unix Ware 7, SVR 5; Unix Ware 2.1, SVR 4.2; QNX 4.25, QNX 6; FreeBSD; Solaris 10; AIX 5.x; and HP-UX 11i.
- ◆ For the *Log Server*, you must have the Microsoft Jet OLEDB 4.0 or higher driver installed.

RJ-45 to Serial Adapters

- ◆ Cat 5e (or higher) cable is required to connect the Serial Console Server to the RJ-45 Serial Adapters (see page 25).
- ◆ The various RJ-45 to Serial Adapters offered by ALTUSEN are shown in the table, below:

Model	Connector	Interface
SA0141	RJ-45 to DB9-F	DTE to DTE
SA0142	RJ-45 to DB9-M	DTE to DCE
SA0143	RJ-45 to DB25-F	DTE to DTE
SA0144	RJ-45 to DB25-M	DTE to DCE
SA0145	RJ-45 to DB9-M	DTE to DTE
SA0146	RJ-45 to DB9-F	DTE to DCE
SA0147	RJ-45 to DB25-M	DTE to DTE
SA0148	RJ-45 to DB25-F	DTE to DCE
SA0149	RJ-45 to DB9-M	PN0108 to PN7/PN5
SA0150	RJ-45 to DB9-F	PN7/PN5/SN to PN0108
SA0151	DB9-F to RJ-45	PC to PN7/PN5

RJ-45 to RJ-45 Cat 5e Cables

- ◆ For serial devices with DB9 or DB25 connectors, use standard straight-through cables.
- ◆ For serial devices with RJ-45 connectors, use rollover cable or specialized pinout cable.

Browsers

Supported browsers for logging into the device include the following:

Browser		Version
IE		6 and higher
Chrome		8.0 and higher
Firefox	Windows	3.5 and higher
	Linux	3.0 and higher
Safari	Windows	4.0 and higher
	Mac	3.1 and higher
Opera		10.0 and higher
Mozilla	Windows	1.7 and higher
	SUN	1.7 and higher

Components

SN0108A Front View

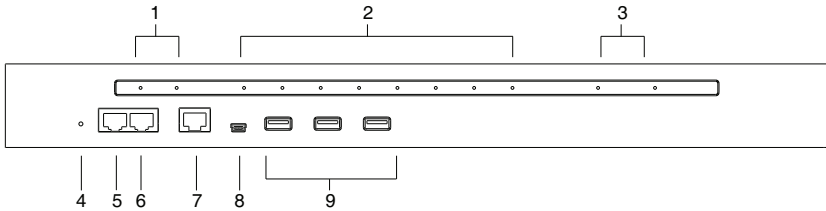

SN0116A Front View

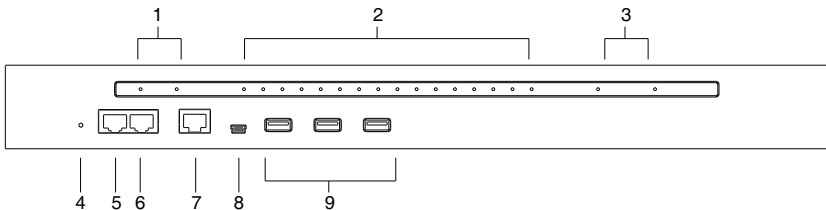

No.	Component	Description
1	Power LEDs	Lights when the unit is powered up and ready to operate.
2	Port LEDs	The Port <ul style="list-style-type: none"> ◆ Flashes Green: Active – data is being transmitted through the port
3	LAN LEDs	Primary and Secondary 10/100/1000 Mbps LAN LEDs. <ul style="list-style-type: none"> ◆ RED: 10 Mbps ◆ RED + GREEN (ORANGE): 100 Mbps ◆ GREEN: 1000 Mbps ◆ Flashes to indicate that the Serial Console Server is being accessed over the LAN.

No.	Component	Description
4	Reset Switch	<p>Note: This switch is recessed and must be pushed with a small object such as the end of a paper clip, or a ballpoint pen.</p> <ul style="list-style-type: none">◆ Pressing and releasing this switch when the unit is running performs a system reset.◆ Pressing and holding this switch in for more than three seconds when the unit is running resets its configuration to the factory default settings. <p>Note: This does not clear User Account information. See <i>Clear Login Information</i>, page 146, for information on clearing user account information.</p> <ul style="list-style-type: none">◆ Pressing and holding this switch while powering on the switch returns the unit to its factory default firmware level, rather than the firmware version that the switch has been upgraded to. This allows you to recover from a failed firmware upgrade and gives you the opportunity to try upgrading the firmware again. <p>Note: This operation should only be performed in the event of a firmware upgrade failure that results in the device becoming inoperable.</p>
5	PON Port	<p>This connector is provided for a Power over the Net™ (PON) unit which allows servers attached to the Serial Console Server to be booted remotely. See <i>Serial Console Server Installation</i>, page 25, step 5 for installation details.</p> <p>Contact your dealer for more information regarding PON units.</p>
6	Modem Port	<p>For dial in connection should the unit be unavailable over the network. See <i>Serial Console Server Installation</i>, page 25, step 6 for installation details.</p>
7	Local Console Port	<p>This RJ45 port allows for local administration and access through a serial terminal connection to a computer. An SA0141 (DTE to DTE) adapter (included in the package) is required for this connection.</p>
8	Laptop USB Console Port	<p>This mini-USB port allows a PC or laptop to be connected for local access and control. Connect to a PC or laptop to automatically launch a terminal emulator to access the SN text menu.</p>
9	USB Ports	<p>These three Type A female USB ports can be used to connect USB devices, such as USB storage devices (pen drive / hard drive), USB hubs and USB LAN cards.</p>

SN0132 Front View

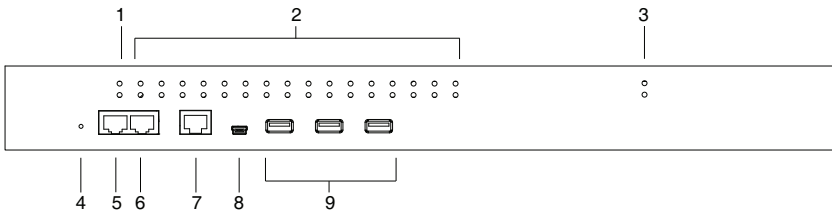

SN0148 Front View

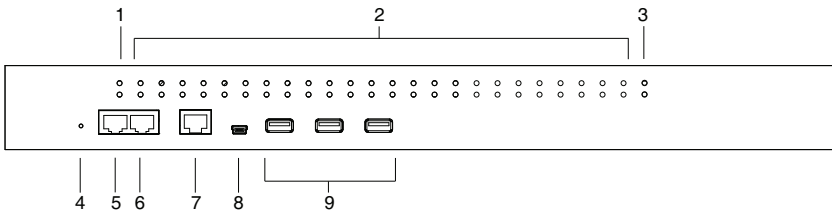

No.	Component	Description
1	Power LEDs	Lights when the unit is powered up and ready to operate.
2	Port LEDs	The Port LEDs provide status information about their corresponding serial ports. <ul style="list-style-type: none"> ◆ Lights Green: Online – the serial device attached to the port is powered on and ready. ◆ Flashes Green: Active – data is being transmitted through the port
3	LAN LEDs	Primary and Secondary 10/100/1000 Mbps LAN LEDs. <ul style="list-style-type: none"> ◆ RED: 10 Mbps ◆ RED + GREEN (ORANGE): 100 Mbps ◆ GREEN: 1000 Mbps ◆ Flashes to indicate that the Serial Console Server is being accessed over the LAN.

No.	Component	Description
4	Reset Switch	<p>Note: This switch is recessed and must be pushed with a small object such as the end of a paper clip, or a ballpoint pen.</p> <ul style="list-style-type: none"> ◆ Pressing and releasing this switch when the unit is running performs a system reset. ◆ Pressing and holding this switch in for more than three seconds when the unit is running resets its configuration to the factory default settings. <p>Note: This does not clear User Account information. See <i>Clear Login Information</i>, page 146, for information on clearing user account information.</p> <ul style="list-style-type: none"> ◆ Pressing and holding this switch while powering on the switch returns the unit to its factory default firmware level, rather than the firmware version that the switch has been upgraded to. This allows you to recover from a failed firmware upgrade and gives you the opportunity to try upgrading the firmware again. <p>Note: This operation should only be performed in the event of a firmware upgrade failure that results in the device becoming inoperable.</p>
5	PON Port	<p>This connector is provided for a Power over the Net™ (PON) unit which allows servers attached to the Serial Console Server to be booted remotely. See <i>Serial Console Server Installation</i>, page 25, step 5 for installation details.</p> <p>Contact your dealer for more information regarding PON units.</p>
6	Modem Port	<p>For dial in connection should the unit be unavailable over the network. See <i>Serial Console Server Installation</i>, page 25, step 6 for installation details.</p>
7	Local Console Port	<p>This RJ45 port allows for local administration and access through a serial terminal connection to a computer. An SA0141 (DTE to DTE) adapter (included in the package) is required for this connection.</p>
8	Laptop USB Console Port	<p>This mini-USB port allows a PC or laptop to be connected for local access and control. Connect to a PC or laptop to automatically launch a terminal emulator to access the SN text menu.</p>
9	USB Ports	<p>These three Type A female USB ports can be used to connect USB devices, such as USB storage devices (pen drive / hard drive), USB hubs and USB LAN cards.</p>

SN9108 Front View

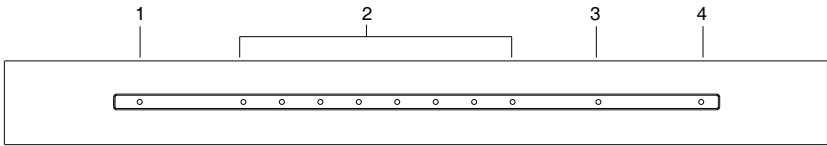

SN9116 Front View

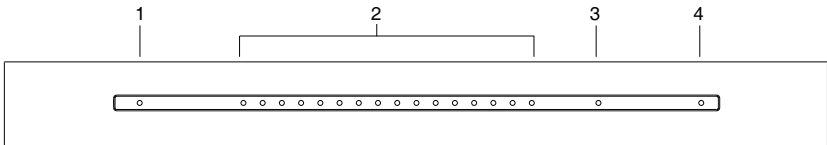

No.	Component	Description
1	Power LED	Lights when the unit is powered up and ready to operate.
2	Port LEDs	<p>The Port LEDs provide status information about their corresponding serial ports.</p> <ul style="list-style-type: none"> ◆ Lights Green: Online – the serial device attached to the port is powered on and ready. ◆ Flashes Green: Active – data is being transmitted through the port
3	LAN LED	<p>Primary and Secondary 10/100/1000 Mbps LAN LEDs.</p> <ul style="list-style-type: none"> ◆ RED: 10 Mbps ◆ RED + GREEN (ORANGE): 100 Mbps ◆ GREEN: 1000 Mbps ◆ Flashes to indicate that the Serial Console Server is being accessed over the LAN.

No.	Component	Description
4	Reset Switch	<p data-bbox="342 153 932 201">Note: This switch is recessed and must be pushed with a small object such as the end of a paper clip, or a ballpoint pen.</p> <ul data-bbox="342 209 932 336" style="list-style-type: none"><li data-bbox="342 209 932 256">◆ Pressing and releasing this switch when the unit is running performs a system reset.<li data-bbox="342 264 932 336">◆ Pressing and holding this switch in for more than three seconds when the unit is running resets its configuration to the factory default settings. <p data-bbox="364 344 932 416">Note: This does not clear User Account information. See <i>Clear Login Information</i>, page 146, for information on clearing user account information.</p> <ul data-bbox="342 424 932 568" style="list-style-type: none"><li data-bbox="342 424 932 568">◆ Pressing and holding this switch while powering on the switch returns the unit to its factory default firmware level, rather than the firmware version that the switch has been upgraded to. This allows you to recover from a failed firmware upgrade and gives you the opportunity to try upgrading the firmware again. <p data-bbox="364 576 932 647">Note: This operation should only be performed in the event of a firmware upgrade failure that results in the device becoming inoperable.</p>

SN0108A Rear View



SN0116A Rear View

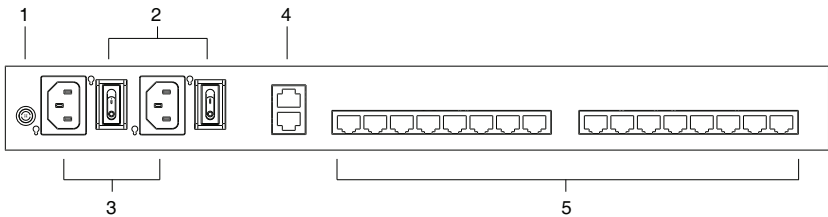

No.	Component	Description
1	Grounding Terminal	The grounding wire that is used to ground the unit attaches here.
2	Power Switches	These standard rocker switches power the unit on and off.
3	Power Sockets	The power cable(s) plugs in here.
4	LAN Ports	The cables that connect the unit to the primary and the backup network interfaces (10/100/1000 Mbps) plug in here.
5	Serial Ports	The Cat 5e cables that connect to the serial devices or RJ45-to-Serial adapters plug in here.

SN0132 Rear View (AC Power)

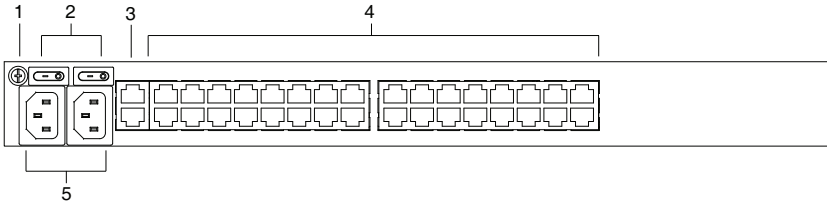

SN0148 Rear View (AC Power)

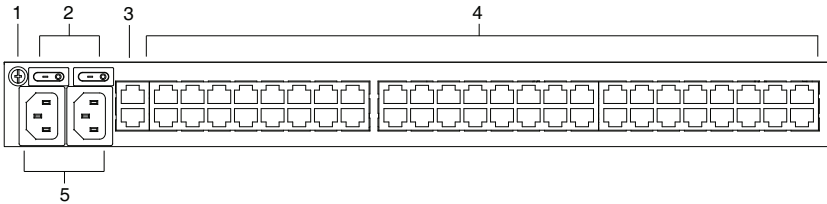

No.	Component	Description
1	Grounding Terminal	The grounding wire that is used to ground the unit attaches here.
2	Power Switches	These standard rocker switches power the unit on and off.
3	LAN Ports	The cables that connect the unit to the primary and the backup network interfaces (10/100/1000 Mbps) plug in here.
4	Serial Ports	The Cat 5e cables that connect to the serial devices or RJ45-to-Serial adapters plug in here.
5	Power Sockets	The power cable(s) plugs in here.

SN0132 Rear View (DC Power)

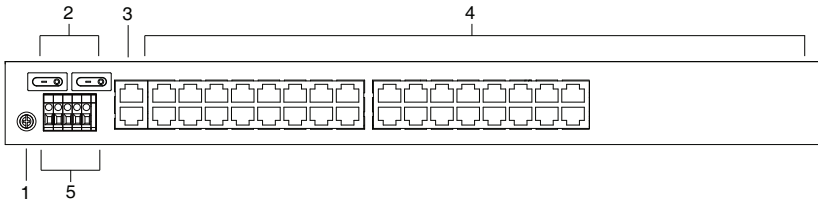

SN0148 Rear View (DC Power)

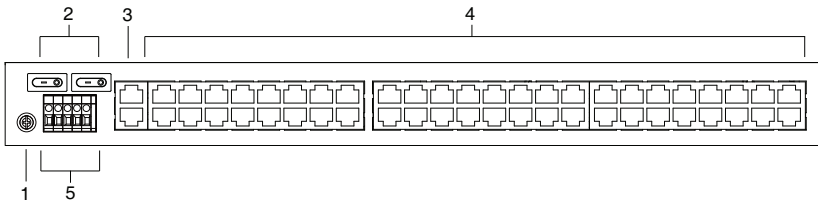

No.	Component	Description
1	Grounding Terminal	The grounding wire that is used to ground the unit attaches here.
2	Power Switches	These standard rocker switches power the unit on and off.
3	LAN Ports	The cables that connect the unit to the primary and the backup network interfaces (10/100/1000 Mbps) plug in here.
4	Serial Ports	The Cat 5e cables that connect to the serial devices or RJ45-to-Serial adapters plug in here.
5	DC Terminal Block	The electric leads from your power source connect to this DC terminal block.

SN9108 Rear View

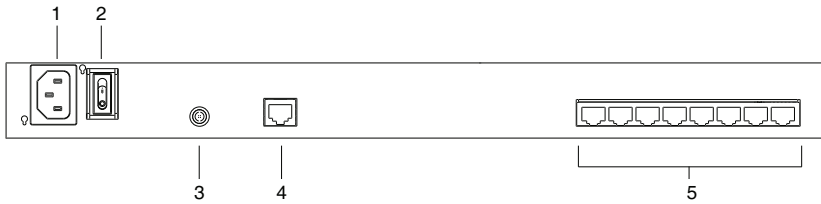

SN9116 Rear View

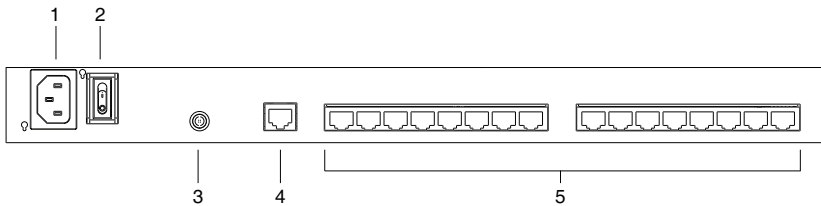

No.	Component	Description
1	Power Socket	The power cable(s) plugs in here.
2	Power Switch	This standard rocker switches power the unit on and off.
3	Grounding Terminal	The grounding wire that is used to ground the unit attaches here.
4	LAN Port	The cable that connect the unit to the network interface (10/100/1000 Mbps) plugs in here.
5	Serial Ports	The Cat 5e cables that connect to the serial devices or RJ45-to-Serial adapters plug in here.

Chapter 2

Hardware Setup

Before You Begin



1. Important safety information regarding the placement of this device is provided on page 131. Please review it before proceeding.
2. Make sure that the power to any device that you connect to the installation has been turned off. You must unplug the power cords

Stacking and Rack Mounting

The Serial Console Server can be stacked on the desktop or rack mounted in a variety of ways. The following sections take you through the procedures for each method.

Stacking

The Serial Console Server can be placed on any appropriate level surface that can safely support its weight plus the weight of its attached cables. To place the device, or to stack units if you are daisy-chaining them, remove the backing material from the bottom of the rubber feet that came with your package, and stick them onto the device's bottom panel at the corners, as shown in the diagram, on the following page:

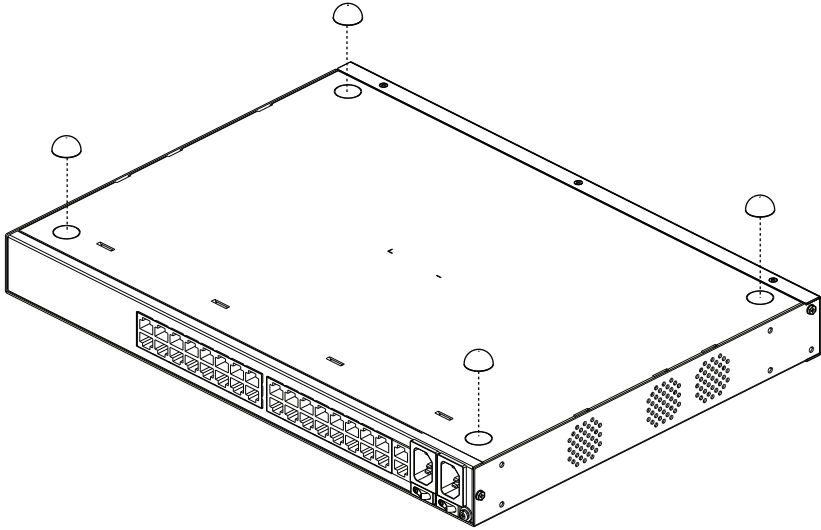

Note: To ensure adequate ventilation, allow at least 5.1 cm on each side, and 12.7 cm behind the unit for power cord and cable clearance.

Rack Mounting

The Serial Console Server can be mounted in a 19" (1U) rack. The mounting brackets can screw into either the front or the back of the unit so that it can attach to the front or the back of the rack.

Rack Mounting - Front

To mount the unit at the front of the rack, do the following:

1. Remove the two screws at the front of the unit.

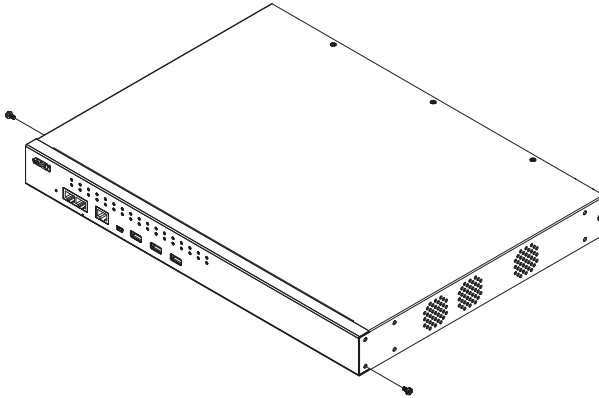

2. Use the M3 x 8 Phillips head hex screws supplied with the rack mount kit to screw the rack mounting brackets into the front of the unit.

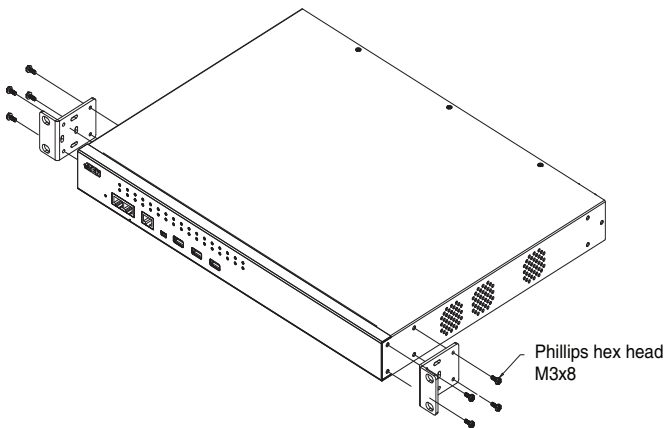

3. Position the device in the front of the rack and align the holes in the mounting brackets with the holes in the rack.
4. Screw the mounting brackets to the rack.

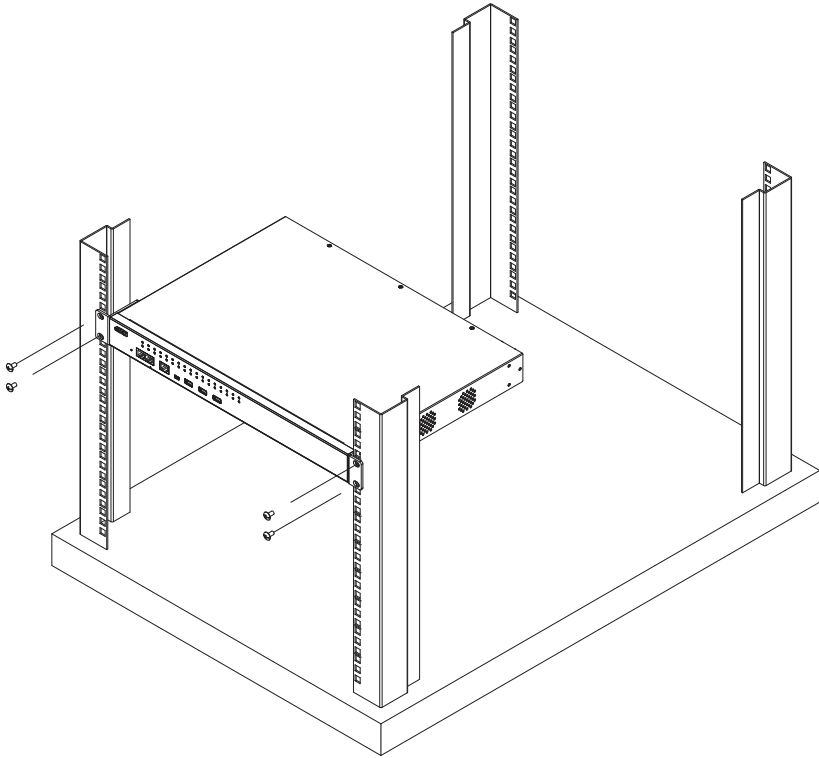

Note: Cage nuts are provided for racks that are not pre-threaded.

Rack Mounting - Rear

To mount the unit at the rear of the rack, do the following:

1. Remove the two screws at the rear of the unit.

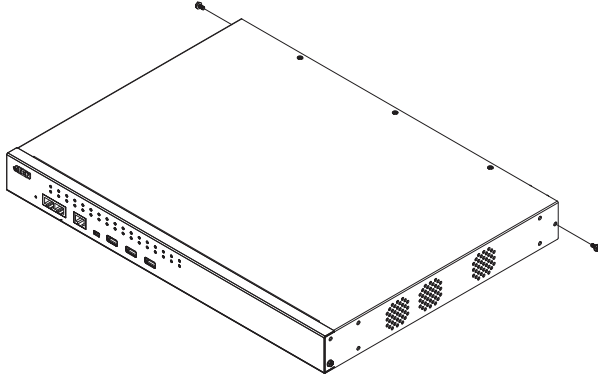

2. Use the M3 x 8 Phillips head hex screws supplied with the rack mounting kit to screw the rack mounting brackets into the rear of the unit.

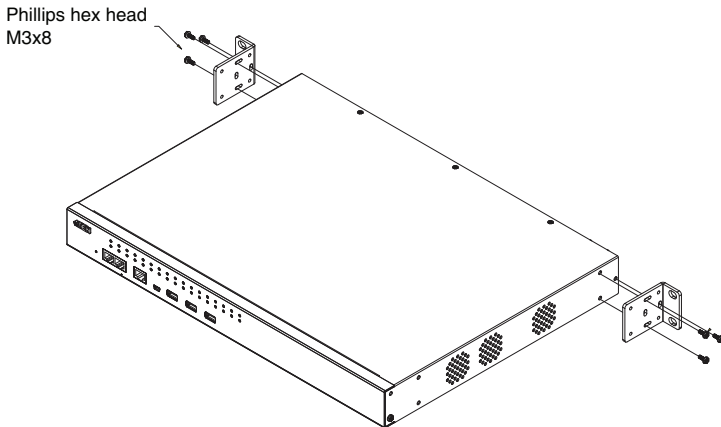

3. Position the device in the rack and align the holes in the mounting brackets with the holes in the rack.

4. Screw the mounting brackets to the rear of the rack.

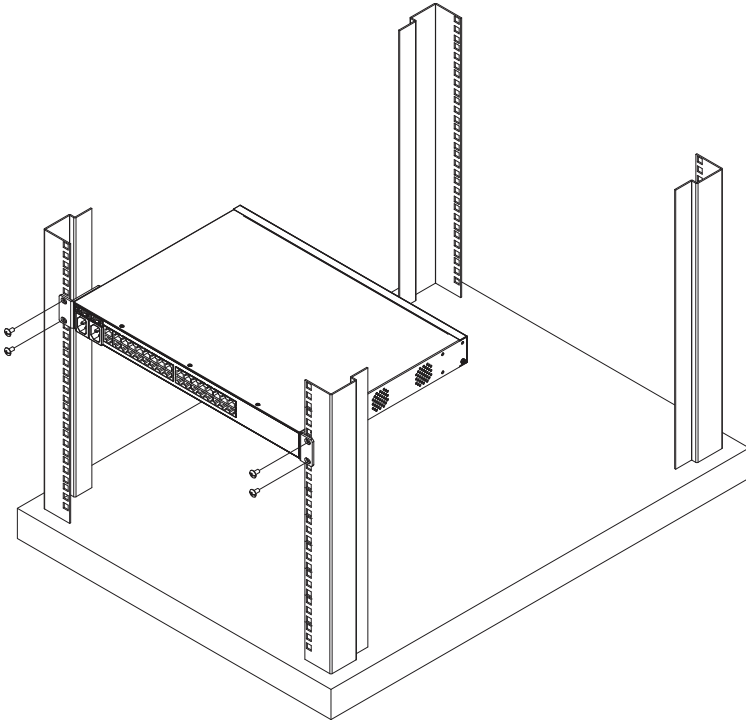

Note: Cage nuts are provided for racks that are not pre-threaded.

Serial Console Server Installation

SN0108A / SN0116A / SN0132 / SN0148 Installation

To set up your SN0108A / SN0116A / SN0132 / SN0148 installation, refer to the Installation Diagram on page 27. The numbers in the diagram correspond to the numbers of the instruction steps, below:

1. Use a grounding wire to ground the unit by connecting one end of the wire to the Serial Console Server's grounding terminal (located on the back panel), and the other end of the wire to a suitable grounded object.

Note: Do not omit this step. Proper grounding helps to prevent damage to the unit from surges or static electricity.

2. For each server or serial device with a DB9 connector, plug an RJ-45-to-Serial adapter into its serial port. Use standard straight-through Ethernet cable to connect any available port on the Serial Console Server's rear panel to the RJ-45-to-Serial adapter

Note: Two RJ-45-to-Serial adapters (1 x SA0142; 1 x SA0141) are included in the SN0108A / SN0116A / SN0132 / SN0148 package. Additional adapters require a separate purchase. Please contact your dealer.

3. For serial devices with RJ-45 connectors, use Ethernet rollover cable or a special pin-out cable to connect any available port on the Serial Console Server's rear panel to serial RJ-45 port.
4. Plug the cables that connect the SN0108A / SN0116A / SN0132 / SN0148 to the network into the primary and backup LAN ports, located on the unit's rear panel.
5. (Optional)
 - a. Use Cat 5e cable to connect the SN0108A / SN0116A / SN0132 / SN0148's PON port to an SA0150 adapter. Connect the adapter to the PON IN port of a PN0108 Power Over the Net™ device.
 - b. Use Cat 5e cable to connect the SN0108A / SN0116A / SN0132 / SN0148's PON port to the PON IN port of a PN5xxx / PN7xxx Power Over the Net™ device.

(Continues on next page.)

6. (Optional)

If you choose to install a serial modem for OOB operation (see *OOBC*, page 106), use standard Cat 5e cable to connect the modem port on the SN0108A / SN0116A / SN0132 / SN0148's front panel to a DTE-to-DCE serial adapter (see *RJ-45 to Serial Adapters*, page 7 for details on choosing the appropriate adapter), then plug the adapter into the modem's serial port. For SN9108 / SN9116 models you can use any available port on the rear of the unit.

7. (Optional)

If you wish to use a console terminal connection, use Cat 5e cable to connect the SN0108A / SN0116A / SN0132 / SN0148 Console port to the DTE -to-DTE serial adapter SA0141 or SA0143. Connect the adapter's serial connector to the console terminal or the COM port of the computer you will use for the console terminal.

8. (Optional)

If you are using a laptop USB console to control the SN0108A / SN0116A / SN0132 / SN0148 locally, use the laptop USB cable included in the package to connect the laptop to the LUC port, located on the unit's front panel.

9. (Optional)

If you are using USB devices (such as USB storage devices [pen drive / hard drive], USB hubs, USB LAN cards) in your installation, connect them to these three Type A female USB ports.

10. For AC models: Use the AC power cord provided with this package to connect the SN0108A / SN0116A / SN0132 / SN0148's Power Socket to an AC power source. For DC models: Connect the DC power source to the SN0132D / SN0148D's DC terminal block.

SN0108A / SN0116A / SN0132 / SN0148 Installation Diagram

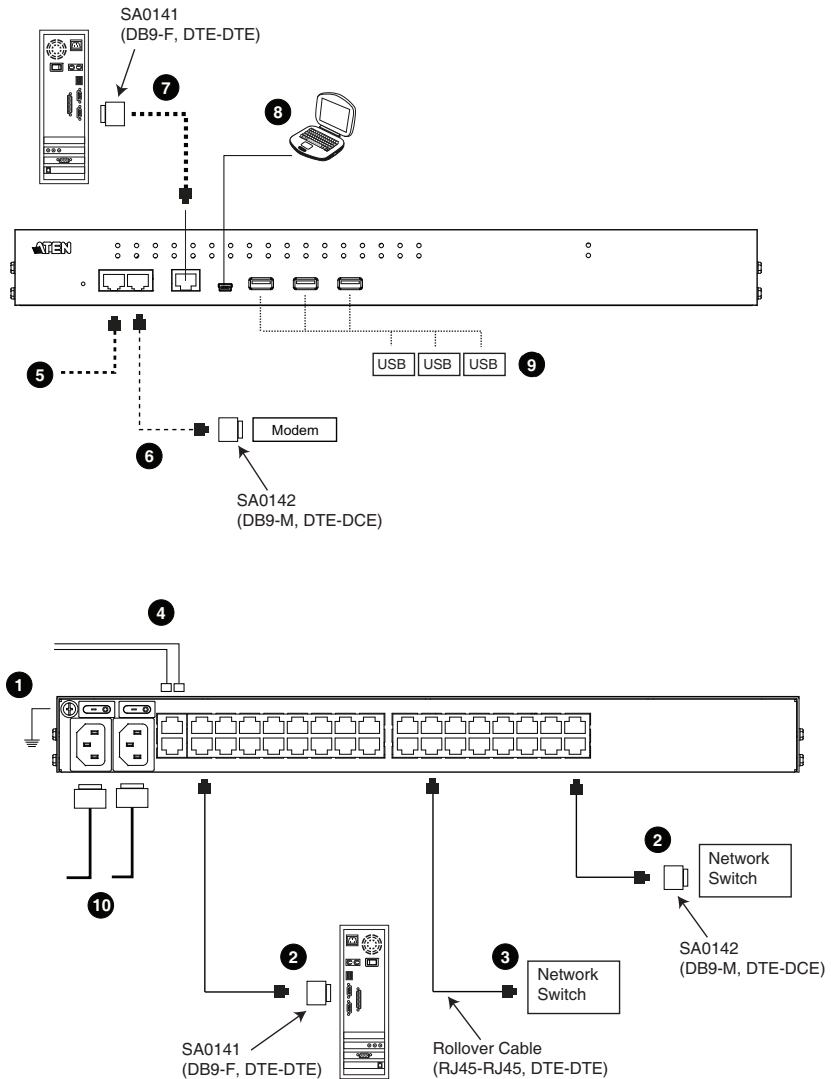

Note: The example above shows a SN0148 Serial Console Server. The SN0108A / SN0116A / SN0132 units have the same ports and switches but with slightly different layouts. See *Components*, page 9 for details.

SN9108 / SN9116 Installation

To set up your SN9108 / SN9116 installation, refer to the Installation Diagram on page 29. The numbers in the diagram correspond to the numbers of the instruction steps, below:

1. Use a grounding wire to ground the unit by connecting one end of the wire to the Serial Console Server's grounding terminal (located on the back panel), and the other end of the wire to a suitable grounded object.

Note: Do not omit this step. Proper grounding helps to prevent damage to the unit from surges or static electricity.

2. For each server or serial device with a DB9 connector, plug an RJ-45-to-Serial adapter into its serial port. Use standard straight-through Ethernet cable to connect any available port on the Serial Console Server's rear panel to the RJ-45-to-Serial adapter

Note: Additional adapters require a separate purchase. Please contact your dealer.

3. For serial devices with RJ-45 connectors, use Ethernet rollover cable or a special pin-out cable to connect any available port on the Serial Console Server's rear panel to the serial RJ-45 port.
4. Plug the cable that connects the SN9108 / SN9116 to the network into the LAN port, located on the unit's rear panel.
5. (Optional)
 - a. Use Cat 5e cable to connect any available port on the SN9108 / SN9116 to an SA0150 adapter. Connect the adapter to the PON IN port of a PN0108 Power Over the Net™ device. Then use OOB to specify the PON port in the *PON Settings* (see *OOBC*, page 106).
 - b. Use Cat 5e cable to connect any available port on the SN9108 / SN9116 to the PON IN port of a PN5xxx / PN7xxx Power Over the Net™ device. Then use OOB to specify the PON port in the *PON Settings* (see *OOBC*, page 106).
6. (Optional)

If you choose to install a serial modem for OOB operation (see *OOBC*, page 106), use standard Cat 5e cable to connect any available port on the SN9108 / SN9116 to a DTE-to-DCE serial adapter (see *RJ-45 to Serial Adapters*, page 7 for details on choosing the appropriate adapter), then

plug the adapter into the modem's serial port. Then use OOB to specify the modem port in the *Modem Settings* (see *OOBC*, page 106)

7. (Optional)

If you wish to use a console terminal connection, use Cat 5e cable to connect any available port on the SN9108 / SN9116 to the DTE -to-DTE serial adapter SA0141 or SA0143. Connect the adapter's serial connector to the console terminal or the COM port of the computer you will use for the console terminal. Then use OOB to specify the console port in the *Console Settings* (see *OOBC*, page 106).

8. Use the AC power cord provided with this package to connect the SN9108 / SN9116's Power Socket to an AC power source.

SN9108 / SN9116 Installation Diagram

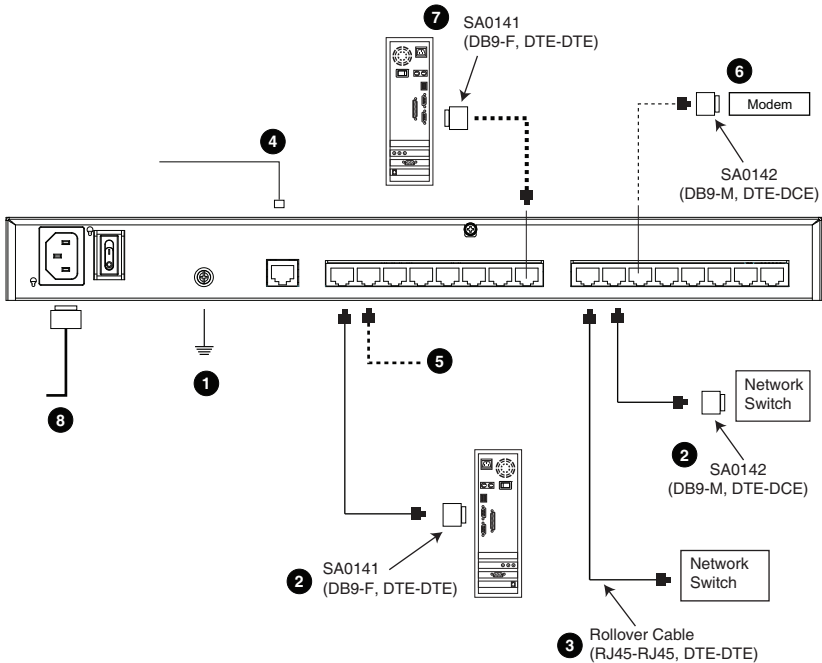

This Page Intentionally Left Blank

Chapter 3

Super Administrator Setup

Overview

This chapter discusses the administrative procedures that the Super Administrator performs to get the Serial Console Server set up for the first time.

First Time Setup

Once the Serial Console Server has been cabled up, the Super Administrator needs to set up the unit for operation. This involves setting the network parameters, and changing the default Super Administrator login. The most convenient way to do this for the first time is from a local console (local VT console or a local computer running terminal application software, such as Microsoft HyperTerminal), or a Laptop USB Console (LUC) running the SNViewerUSB application (SN0108A / SN0116A / SN0132 / SN0148 only). Setup can also be done remotely over the Web via the GUI using the unit's IP address.

Note: For remote methods of setting up the network, see *IP Address Determination*, page 139.

Local Login

You can login locally from a computer or laptop (SN0108A / SN0116A / SN0132 / SN0148 only) connected directly to the Serial Console Server (see *Serial Console Server Installation*, page 25). There are two methods for logging in locally *SNViewerUSB* and *HyperTerminal*.

The local login Main Menu is the text based equivalent of the browser based configuration and control functions described throughout this manual. You can reference the detailed information provided for the web browser version (*Browser Login*, page 35) as you work your way through the sub-menus to configure the settings discussed in this chapter.

Laptop USB Console (LUC) Login - SNViewerUSB

The *SNViewerUSB* application appears automatically when a Laptop USB Console (LUC) connection (SN0108A / SN0116A / SN0132 / SN0148 only) has been established, and you will be prompted to login, as shown here:

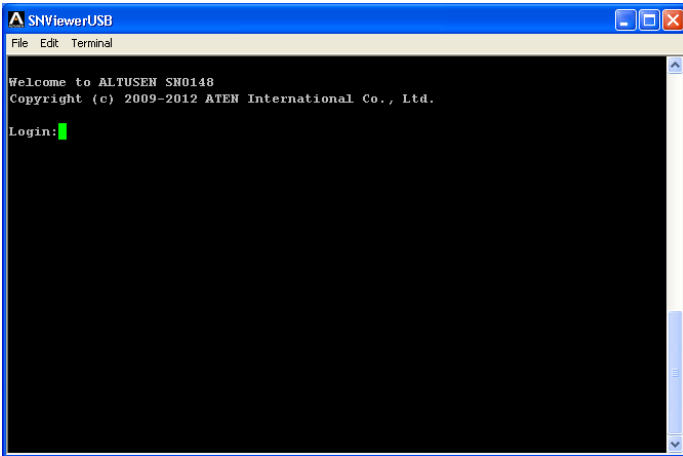

Since this is the first time you are logging in, use the default Username: *administrator*; and the default Password: *password*.

Console Login - HyperTerminal

Once a physical connection from a computer to the Serial Console Server has been made you can establish a HyperTerminal session using the instructions below.

1. Open *HyperTerminal*, and configure the port settings for the COM1 port:

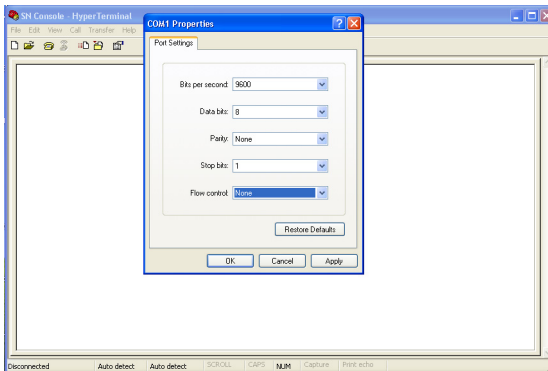

Bits per Second: **9600**, Data Bits: **8**, Parity: **None**, Stop bits: **1**, Flow Control: **None**.

- When configured correctly the login prompt appears, as shown here:

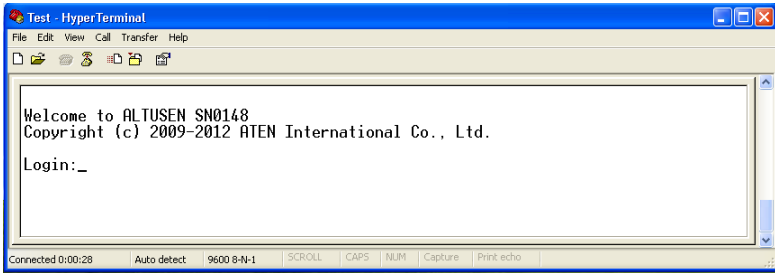

Since this is the first time you are logging in, use the default Username: *administrator*; and the default Password: *password*.

Local Console Main Menu

After you login via *HyperTerminal* or *SNViewerUSB* the text based menu appears:



The Main Menu is the text based equivalent of the browser based configuration and control functions described throughout this manual. You can reference the information provided for the browser version as you work your way through the sub-menus.

Remote Login

You can login remotely from a computer running *Telnet*, *PuTTY*, or via *Web Browser*.

The remote login Main Menu for *Telnet* and *PuTTY* are a text based equivalent of the browser based GUI and control functions as described throughout this manual. You can reference the detailed information provided for the web browser version (*Browser Login*, page 35) as you work your way through the text sub-menus and configure the settings discussed in this chapter.

Telnet Login

Start Telnet, type “*open 192.168.0.60*”, press **Enter**, and a login prompt will appear, as show here:



Since this is the first time you are logging in, use the default Username: *administrator*; and the default Password: *password*.

PuTTY Login

Start PuTTY, enter the Serial Console Server’s default IP address (*192.168.0.60*), click **Open**, and a login prompt will appear, as shown here:

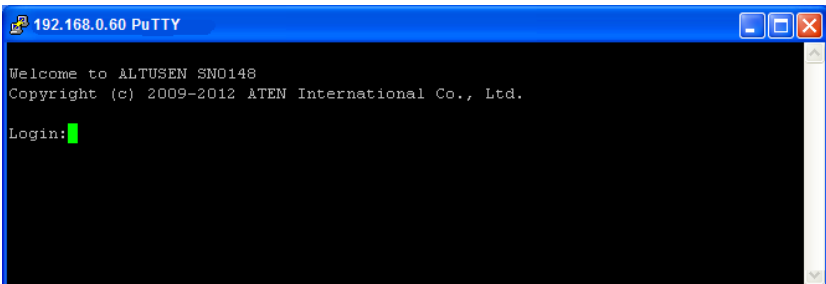

Since this is the first time you are logging in, use the default Username: *administrator*; and the default Password: *password*.

Browser Login

Once the Serial Console Server has been connected to the LAN, it can be accessed via an Internet browser running on any platform. To access the Serial Console Server, do the following:

1. Open the web browser and specify the default IP address (*192.168.0.60*) of the Serial Console Server in the browser's location bar, and press **Enter**.
2. When a Security Alert dialog box appears, accept the certificate, it can be trusted.

Once you accept the certificate(s), the login page appears:

3. Since this is the first time you are logging in, use the default Username: *administrator*; and the default Password: *password*.

Note: For security purposes, you should change these to a unique Username and Password. (See *Changing the Super Administrator Login*, page 37 for details.)

After you successfully log in, the Main Page appears:

Port Number	Port Name	Status	Busy	Operation Mode	Operation
[01]	COM1-- 789012345678901234567890123456789012	-	-	Console Management	Telnet SSH Dump Buffer
[02]	COM2-- 789012345678901234567890123456789012	-	-	Console Management	Telnet SSH Dump Buffer
[03]	COM3-- 789012345678901234567890123456789012	-	-	TCP Server	Dump Buffer
[04]	COM4-- 789012345678901234567890123456789012	-	-	RealCOM Port	Dump Buffer
[05]	COM5-- 789012345678901234567890123456789012	-	-	RealCOM Port	Dump Buffer
[06]	COM6-- 789012345678901234567890123456789012	-	-	RealCOM Port	Dump Buffer
[07]	COM7-- 789012345678901234567890123456789012	-	-	RealCOM Port	Dump Buffer
[08]	COM8-- 789012345678901234567890123456789012	-	-	RealCOM Port	Dump Buffer
[09]	COM9-- 789012345678901234567890123456789012	-	-	RealCOM Port	Dump Buffer
[10]	COM10-- 789012345678901234567890123456789012	-	-	RealCOM Port	Dump Buffer

Setup

Network Setup

To set up the network, do the following:

1. Click the **Device Management** tab.
2. Select the **Network** tab.

The screenshot shows the 'Network Information' configuration page. It is divided into several sections:

- IP Installer:** Three radio buttons: 'Enabled' (selected), 'View Only', and 'Disabled'.
- Service Ports:** A table of port configurations:

HTTP Port:	80	HTTPS Port:	443
SSH Port:	22	Telnet Port:	23
Base Socket:	5001		
- Network Configuration:**
 - Enable Redundant NIC
 - Select a network adapter: 'eth0' (dropdown menu)
 - IPv4 Configuration:**
 - Obtain IP address automatically [DHCP]
 - Set IP address manually [Fixed IP]
 - IP Address: 10.0.90.141
 - Subnet Mask: 255.255.255.0
 - Default Gateway: 10.0.90.254
 - Obtain DNS server address automatically
 - Set DNS server address manually
 - Preferred DNS server: 10.0.0.6
 - Alternate DNS server: 10.0.0.7
 - IPv6 Configuration:**
 - Obtain IP address automatically [DHCP]
 - Set IP address manually [Fixed IP]
 - IP Address: 2008::1
 - Prefix Length: 64
 - Default Gateway: 2008::1
 - Obtain DNS server address automatically
 - Set DNS server address manually
 - Preferred DNS server: fe80::210:74ff:fe48:20c
 - Alternate DNS server: fe80::210:74ff:fe48:20c

A 'Save' button is located at the bottom right of the configuration area.

3. Fill in the fields according to the information provided under *Network*, page 93.

Changing the Super Administrator Login

To change the default Super Administrator Username and Password, do the following:

1. At the top of the screen, click the **User Management** tab.

The User Management page has a list of Users and Groups in the Sidebar at the left, and a more detailed list of users – with more information about them – in the large central panel. Since this is the first time the page is being accessed, only the Super Administrator appears:

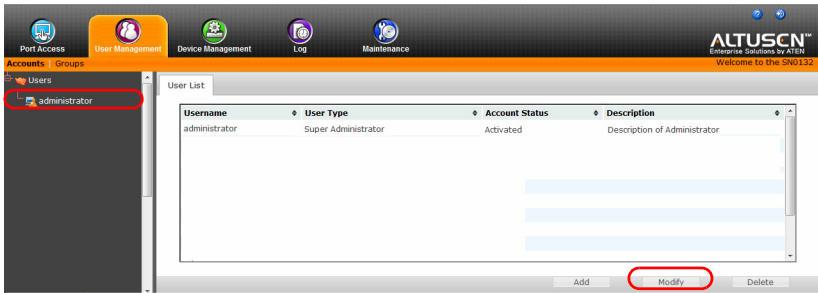

2. Click on the account in the left panel or select it in the central panel, then click **Modify** (at the bottom of the page.)

The *User Information* page appears:

The screenshot shows the 'User Information' form for the 'administrator' user. The form is divided into two sections: 'General' and 'Role'. In the 'General' section, there are four fields: 'Username' (containing 'administrator'), 'Password' (masked with dots), 'Confirm Password' (masked with dots), and 'Description' (containing 'Description of Administrator'). There is a checked checkbox for 'Local User'. In the 'Role' section, there are three radio buttons: 'Super Administrator' (selected), 'Administrator', and 'User'.

3. Change the Username and Password to something unique.
4. Enter the password again in the *Confirm Password* field to confirm it is correct.
5. Click **Save** (located at the bottom of the page).
6. When the dialog box informing you that the change completed successfully appears, Click **OK**.

This Page Intentionally Left Blank

Chapter 4

The User Interface

Overview

Once you have successfully logged in, the Serial Console Server's Main Page appears. The look of the page varies slightly, depending on which method you used to log in. Each of the interfaces is described in the sections that follow.

Access

The Serial Console Server can be accessed from a local console (locally connected computer or laptop) running terminal application software (such as Microsoft HyperTerminal) or the SNViewerUSB application; or from a remote computer using Telnet (SSH), PuTTY, or web-based browser (see *First Time Setup*, page 31 for details).

No matter which access method you choose, the Serial Console Server's authentication procedure requires you to submit a valid username and password. If you supply invalid login information, the authentication routine will return an *Invalid Username or Password*, or *Login Failed* message. If you see this type of message, log in again with a correct username and password.

Note: If the number of invalid login attempts exceeds a specified amount, a timeout period is invoked. You must wait until the timeout period expires before you can attempt to log in again. See *Login Failures*, page 109 for further details.

Local Console Operation

When a local console is attached (SN0108A / SN0116A / SN0132 / SN0148 only, see page 25), you can use the *HyperTerminal* or *SNViewerUSB* application to login (See *Local Login*, page 31 for details). Simply key in your valid Username and Password, then hit **[Enter]** to bring up the Local Console Main Page.

```
SN0148      Main Menu
-----
  1.  Preferences
  2.  User Management
  3.  Port Settings
  4.  Port Access
  5.  Device Management

  6.  Sessions

  Q.  Logout

Select one: _
```

The Main Menu is the text based equivalent of the browser based configuration and control functions described throughout this manual. You can reference the information provided for the browser version as you work your way through the sub-menus.

-
- Note:**
1. As with the browser version, access to many of these sub-menus are restricted by the user's permissions. If you select a submenu that you are not authorized for, nothing happens.
 2. Some of the sub-menus do not have an *Exit* choice. In these cases, you can return to the previous menu without making changes by pressing **Enter** twice.
 3. You can bring up the Main Menu at any time during your session.
 4. This menu can also be accessed from remote terminal sessions, such as Windows Telnet Client, and PuTTY.
-

When you have finished with your session, bring up the Main Menu and press **Q** to log out. After you are offline, you can simply close the window.

Remote Operation

You can access the Serial Console Server remotely using a *web browser*, or text based terminal application such as *Telnet* or *PuTTY*, as described below.

Web Browser Login

Serial Console Server units can be accessed via an Internet browser running on any platform. To access the Serial Console Server, do the following:

1. Open the browser and specify the IP address (See *Browser Login*, page 35 for details) of the Serial Console Server you want to access in the browser's location bar.
2. When a Security *Alert* dialog box appears, accept the certificate – it can be trusted. If a second certificate appears, accept it as well.

Once you accept the certificate(s), the login page appears:



The image shows a web browser login interface for a device labeled 'SN0132'. The interface consists of a black header with the text 'SN0132 Login' in white. Below the header, there are two text input fields: one for 'Username' and one for 'Password'. Underneath these fields are two buttons: 'Login' and 'Reset'. At the bottom of the page, there is a logo for 'ALTUSCN™' with the tagline 'Enterprise Solutions by ATEN' below it.

3. Provide your username and password (see *Browser Login*, page 35), then click **Login** to bring up the Web Browser Main Page, described on the next page.

The Web Browser Main Page

To ensure multi-platform operability, access to the Serial Console Server can be accomplished with most standard web browsers. The chapters following this one give detailed information about each section of the web browser. Once users log in and are authenticated (see page 41), the *Web Browser Main Page* comes up, with the Port Access page displayed:

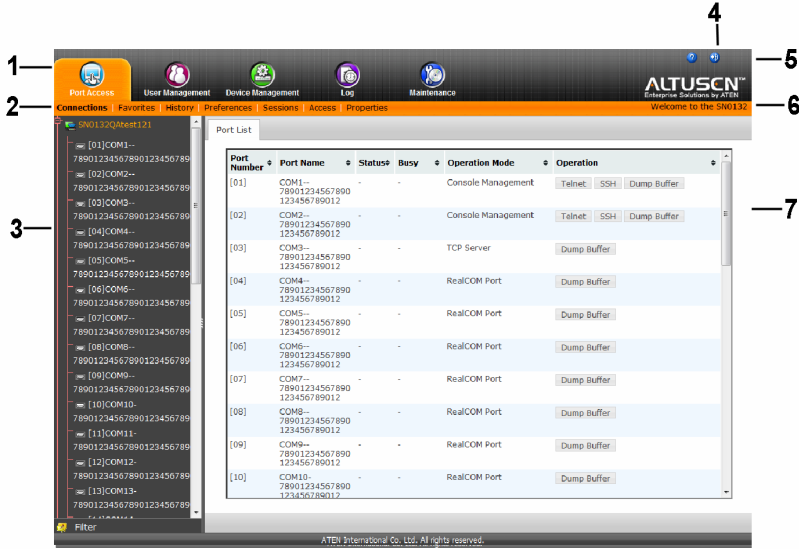

Note: The screen depicts a Super Administrator’s page. Depending on a user’s type and permissions, not all of these elements appear.

Page Components





The web page screen components are described in the table, below:

No.	Item	Description
1	Tab Bar	The tab bar contains the Serial Console Server main operation categories. The items that appear in the tab bar are determined by the user’s type, and the authorization options that were selected when the user’s account was created.
2	Menu Bar	The menu bar contains operational sub-categories that pertain to the item selected in the tab bar. The items that appear in the menu bar are determined by the user’s type, and the authorization options that were selected when the user’s account was created.



No.	Item	Description
3	Sidebar	<p>The Sidebar provides a tree view listing of ports that relate to the various tab bar and menu bar selections. Clicking a node in the Sidebar brings up a page with the details that are relevant to it.</p> <p>There is a <i>Filter</i> button at the bottom of the Sidebar that lets you expand or narrow the scope of the ports that appear in the tree.</p>
4	About	About provides information regarding the Serial Console Server's current firmware version.
5	Logout	Click this button to log out of your Serial Console Server session.
6	Welcome Message	If this function is enabled (see <i>Welcome Message</i> , page 65), a welcome message displays here.
7	Interactive Display Panel	This is your main work area. The screens that appear here reflect your menu choices and Sidebar node selection.

The Tab Bar

The number and type of icons that appear on the Tab Bar at the top of the page are determined by the user's type (Super Administrator, Administrator, User) and the permissions assigned when the user's account was created. The chapters following this one give detailed information about each section of the web browser. The functions associated with each of the icons are explained in the table below:

Icon	Function
	Port Access: The Port Access page is used to access and control the devices on the Serial Console Server installation. This page is available to all users. Port Access is discussed on page 57.
	User Management: The User Management page is used to create and manage Users and Groups. It can also be used to assign devices to them. This tab is available to the Super Administrator, as well as administrators and users who have been given User Management permission. The tab doesn't appear for other administrators and users. User Management is discussed on page 75.
	Device Management: The Device Management page is used to configure and control the overall operation of the Serial Console Server. This page is available to the Super Administrator, as well as administrators and users who have been given Device Management permission. The tab doesn't appear for other administrators and users. Device Management is discussed on page 91.
	Log: The Log page displays the contents of the log file. The Log page is discussed on page 119.
	Maintenance: The Maintenance page is used to install new firmware; backup and restore configuration and account information; restore default values; and import Certificates. This page is available to the Super Administrator (and Administrators and Users with <i>Maintenance</i> permission). The icon doesn't display on the page of ordinary administrators and users. The Maintenance page is discussed on page 123.

There are two small icons at the extreme right of the page. Their functions are described in the table, below:

Icon	Function
	Click this icon to bring up a panel with information about the Serial Console Server's firmware version.
	Click this icon to log out and end your Serial Console Server session.

SNViewer

The *SNViewer* is the main application used to access serial devices via web browser. The *SNViewer* opens from the *Port Access - Connections* page, when you click the **Telnet** or **SSH** button for a serial device (see *Telnet/SSH*, page 61 for details). When the *SNViewer* opens there is a Control Panel toolbar that appears when your mouse moves over it, which allows you to configure your session, as shown here:

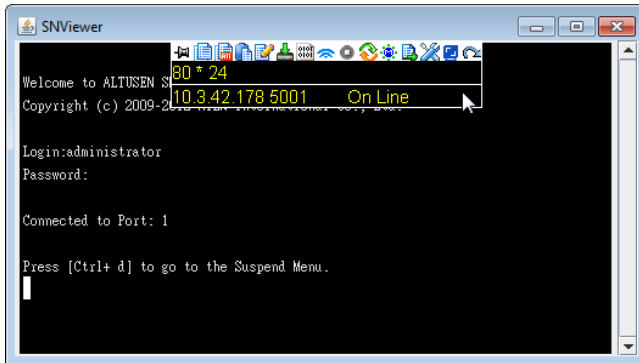

SNViewer Control Panel









The SNViewer provides a Control Panel that is hidden at the upper center of the screen, and becomes visible when your mouse moves over it. The panel consists of three rows: an icon row at the top, and two text rows below it:









- ◆ By default, the upper text row shows the width and height of the window size. As the mouse pointer moves over the icons in the icon bar, however, the information in the upper text row changes to describe the icon's function. In addition, if a message from another user is entered in the message board, and you have not opened the message board in your session, the message board window will pop open automatically.
- ◆ The lower row shows the IP address and port of the device you are accessing on the left side, and the connection status on the right.

Control Panel Functions

The Control Panel functions are described below and in the following sections:

Icon	Function
	This is a toggle. Click to make the Control Panel appear <i>Always On Top</i> – i.e., always displays on top of the SNViewer screen. Click again to have it display in <i>Auto Hide</i> mode— allowing it to only appear when the mouse is moved over it.
	Use this to copy the selected text on the screen.
	Use this to copy all text that is displayed on the screen.
	Use this to paste the copied text.
	Use this icon to toggle <i>Logging on / Logging off</i> . This starts a log file of characters sent from the serial device to the SNViewer. You must first create and import a text based log file (See <i>Terminal Settings, Others - Log File</i> , page 51).
	Use this to browse for data files to import (see <i>Data Import</i> , page 47).
	Use this to change the page encoding (see <i>Encode</i> , page 48).
	Use this icon to enable broadcasting. Broadcasting allows you to access and make changes on a single port and the same changes will be made across all Broadcast Ports. Before using the broadcast function, set the <i>Broadcast Timeout</i> and <i>Broadcast Ports</i> (see <i>Preferences</i> , page 64 for details). For broadcasting to work, you must first access a port set as a Broadcast Port and then click the Broadcast icon on the control panel.
	Click to send a Break command.

Icon	Function
	Use this to reset the terminal to its default settings.
	Click to bring up the Message Board (see <i>The Message Board</i> , page 48).
	Click to open a window and create a list of custom text macros (see <i>Macros</i> , page 49).
	Use this to change the font, color and other SNViewer settings (see <i>Terminal Settings</i> , page 50).
	Use this button to adjust the width of the SNViewer window.
	Click to exit the viewer.



Data Import

The *Data Import* page opens a standard browse menu to import data files, as shown below:

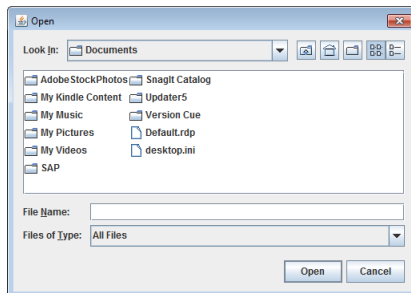



Encode

Encoding allows you select which type of encoding you want to use. Make your selection from the drop down menu and click **OK**, as

shown below:

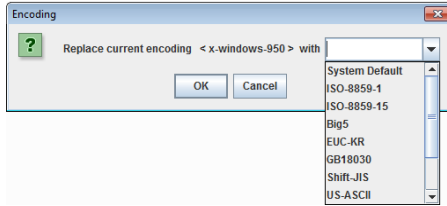

The Message Board

The Serial Console Server supports multiple user logins, which may cause access conflicts. To alleviate the problem, a message board has been provided, which allows users to communicate with each other:

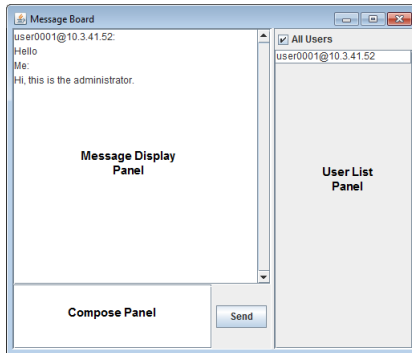

Message Display Panel

Messages that users post to the board are display in this panel.

Compose Panel

Key in the messages that you want to post to the board in this panel. Click **Send** to post the message to the board.

User List Panel

The username and IP address of all the logged in users are listed in this panel.

- ◆ If you check **All Users**, messages are posted to all users. To post a message to one individual user, select the user's name before sending your message.
- ◆ If a user's name is selected, and you want to post a message to all users, select **All Users** before sending your message.



Macros

Macros allow you to create custom text macros to use within the SNViewer application. When you click the Macros icon the following screen appears:

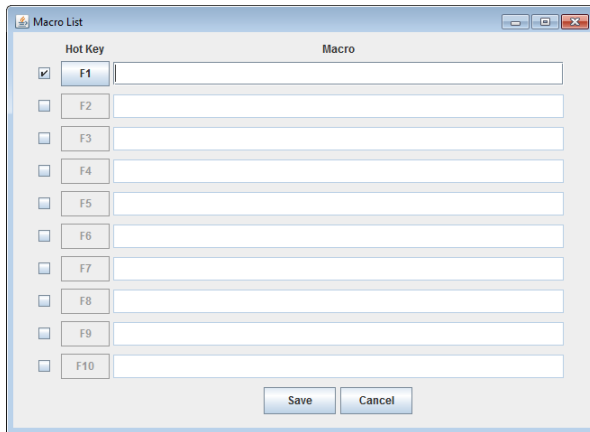

Simply check a box, type in the text macro and click **Save**. Use the associated function key (F1-F12) to run the custom text macro(s) you created. Terminal Application

You can login remotely using a text based terminal application such as *Telnet*, or *PuTTY*. For information on how to connect and login, see *Remote Login*, page 34 for details.

The *Telnet* and *PuTTY* Main Menus are the text based equivalent of the browser based configuration and control functions described throughout this manual. You can reference the information provided for the browser version as you work your way through the sub-menus. Once you login, the following text based menu's appear:



Terminal Settings

The *Terminal Settings* page allows you make changes to the appearance of the terminal window, as described below:

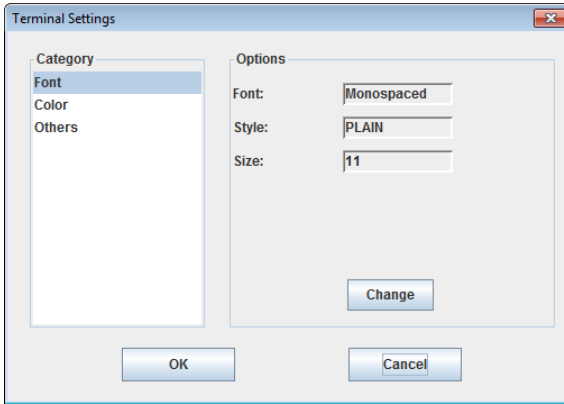

Category	Description
Font	Click Change to configure the SNViewer's Font settings. You can change the <i>Font</i> type, <i>Size</i> , and <i>Style</i> . On the right side of the window you can view an example of the font you have set.
Color	Select an Option : <i>Foreground color</i> , <i>Background Color</i> , <i>Cursor Text color</i> , or <i>Cursor Color</i> , and Click Change to adjust the color settings. Use the <i>HSL</i> , <i>Swatches</i> , and <i>HSV</i> tabs to make detailed adjustments and select the colors. Below the tab is a Preview section you can use to see how the color change will look. Click OK to save the changes; Cancel to remove the changes and exit; or Reset to revert to the default color settings.

Category	Description
Others	<p>Use this section to set:</p> <ul style="list-style-type: none">◆ <i>Implicit CR in every LF</i>: Checking this box adds an extra Carriage Return when the [Enter] key is used, so the cursor returns flush on the left margin. Use this function if the text is not lining up on the left margin after you hit [Enter].◆ <i>Backspace is Delete Key</i>◆ <i>Local echo</i>: An echo is a response from the serial device of character(s) that have been input.<ul style="list-style-type: none">◆ Auto: Characters that are typed in are echoed but not displayed on the screen.◆ Force On: Characters that are typed in are echoed and displayed on the screen as they are entered. <i>Passwords are displayed on the screen if this mode is used.</i>◆ Force Off: Characters are not echoed from the serial device.◆ <i>Buffer Size</i>: This is the maximum size of the Log file.◆ <i>Log File</i>: The log file generates a log of characters sent from the connected serial device to the SNViewer. The log must first be created as a text file using an external editor such as Note or Microsoft Word, then opened here. Next you must turn <i>Logging on</i> from the SNViewer Control Panel (see <i>Control Panel Functions</i>, page 46).

Terminal Application

You can login remotely using a text based terminal application such as Telnet, or PuTTY. For information on how to connect and login, see *Remote Login*, page 34 for details.

The Telnet and PuTTY Main Menus are the text based equivalent of the browser based configuration and control functions described throughout this manual. You can reference the information provided for the browser version as you work your way through the sub-menus. Once you login, the following text based menu's appear:

Telnet Menu-Driven Text UI

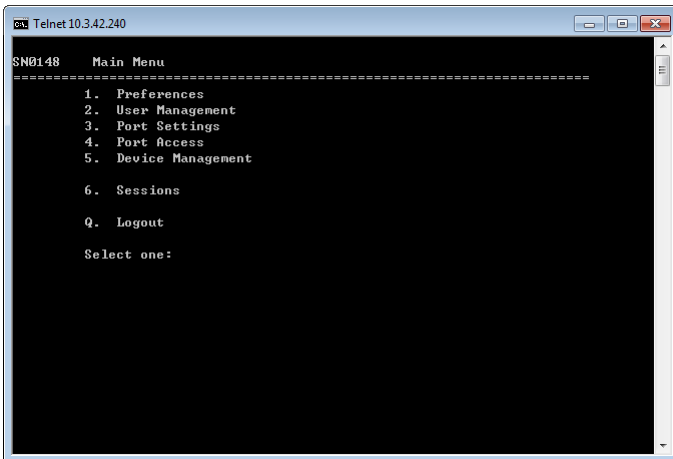

PuTTY Menu-Driven Text UI

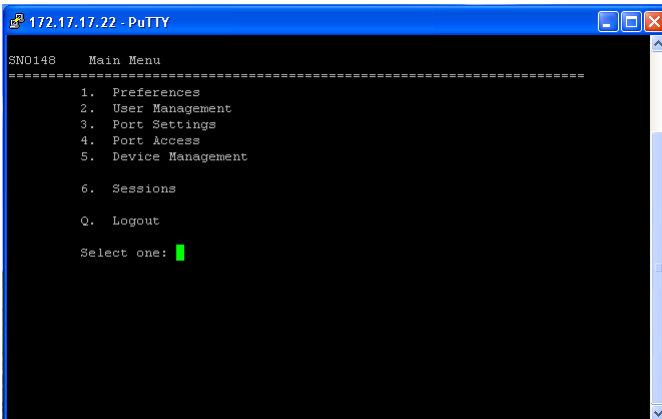

Chapter 5

Port Operating Modes

Overview

To cover a broad range of serial applications, the Serial Console Server's COM ports support several port operating modes. These include *Virtual Modem*, *Serial Tunnel*, *Console Management*, and *Real COM Port* modes, for device control sessions, plus *TCP Server/Client* and *UDP* modes for socket application purposes. An explanation of the functions performed by the various operating modes is provided in the sections that follow.

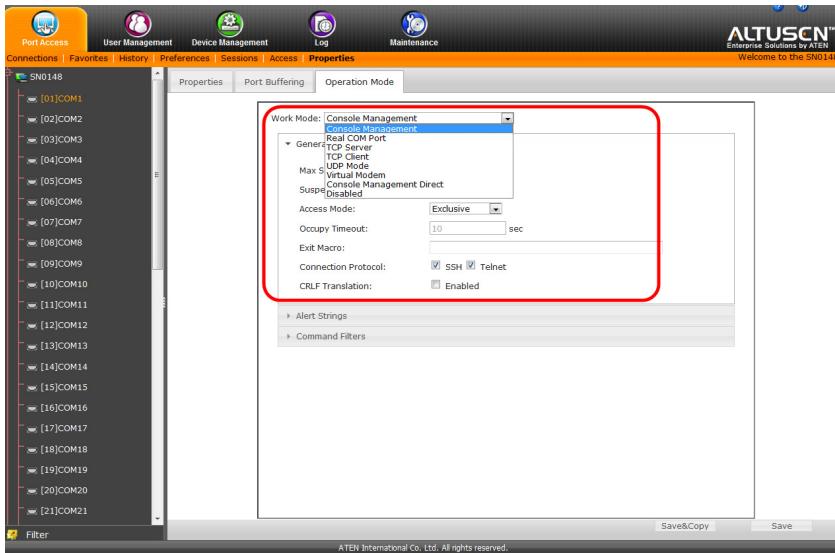

The **Work Mode** is selectable from the *Port Access - Properties* page, under the *Operation Mode* tab, as shown above. From this page you can set the Port Operating Modes that are discussed in this chapter. See *Operating Mode*, page 72, for further details on configuring all the settings.

Work Mode

Console Management

Console Management mode is the most common Work Mode used, allowing users to establish Telnet or SSH sessions to the Serial Console Server to manage the serial devices. In this mode users can login using the web browser's built in SNViewer application via *Telnet* or *SSH*; remotely via Telnet or PuTTY; or directly using the HyperTerminal or SNViewerUSB applications.

Note: Be sure that the *Socket* entry specified on the *Network* page corresponds to the port that the device listens on. 5001 is the Serial Console Server's default setting (see *Network*, page 93, and *Base Socket*, page 94).

Virtual Modem

In *Virtual Modem* mode, the Serial Console Server's COM port emulates a modem. The port acts as if it were a real modem for communication with a remote server. This allows software designed to transmit data over a serial modem-to-modem link, to perform serial operations over a TCP/IP Ethernet connection. In this mode, the Serial Console Server "dials into" the remote server's IP specifying the appropriate port address for the transmission. For example:

```
atd 10.0.100.101:5000
```

A detailed description of the data structures and related functions of the Serial Console Server's virtual modem function is provided on page 143.

Note: 128-bit SSL data encryption is supported in this operating mode.

Real COM Port

This mode is used in conjunction with a virtual COM port driver installed on the remote user's local computer. When the Serial Console Server's COM port is set to this mode, the device connected to the port appears as if it were a device directly connected to a COM port on the remote user's local computer.

This mode is useful with devices such POS terminals, Bar Code Readers, Serial printers, etc. since it allows you to use software that was written for pure serial communication applications. It can be used with other ALTUSEN management products, such as the PN5/PN7 Power Over the NET™.

The Serial Console Server comes with Real COM drivers for Windows systems and TTY drivers for Linux systems.

TCP Server / TCP Client

TCP (Transmission Control Protocol) provides a reliable transport layer for transmitting serial data over the TCP protocol via socket programming.

TCP Server (RAW TCP)

In *TCP Server* (RAW TCP) mode, data transmission is bidirectional. In this mode, the host computer initiates contact with the Serial Console Server and requests a connection to its serial port.

Once the connection is established, the host receives data from the serial device. From this point on, data can be transmitted between the host and the device in both directions. 128-bit SSL data encryption is supported in this operating mode.

The Serial Console Server supports simultaneous connections from up to 16 host computers in this mode, allowing multiple computers to communicate with the serial device at the same time.

Note: Be sure that the *Socket* entry specified on the *Network* page corresponds to the port that the device listens on. 5301 is the Serial Console Server's default setting. (see *Network*, page 93, and *Base Socket*, page 94).

TCP Client

In *TCP Client* mode, when serial data comes into the Serial Console Server's serial port, the Serial Console Server initiates contact with the host computer and begins sending serial data to the to the host. The Serial Console Server can send data to up to 16 host computers simultaneously, and supports 128-bit SSL data encryption in this operating mode.

UDP Mode

UDP (User Datagram Protocol) *Mode* is faster and more efficient at communications than TCP. In UDP mode, communications are bilateral. A serial device can send data to, and receive data from, up to 16 host computers via the Serial Console Server's COM port.

Because it doesn't perform error checking in the thorough way that TCP does, UDP is more suitable for real time applications (such as message display) than the slower TCP which is optimized for data accuracy.

Serial Tunnel

Serial Tunnel involves establishing a direct connection between two Serial Console Server's over Ethernet. Serial Tunnel works in a *master/slave* relationship. One unit is designated master, the other designated slave.

Note: In this configuration, it doesn't matter which one is designated master and which one is designated slave.

The COM port of one unit connects to the COM port of a computer; the COM port of the other unit connects to the serial device that will be accessed.

The units communicate with each other via their IP and port addresses. The port address is set with the Socket entry of the Network Configuration settings. See *Network*, page 93, and *Base Socket*, page 94, for details.

Chapter 6

Port Access

Overview

Once you have logged in from a web browser, the Main Screen appears with the *Port Access - Connections* page displayed:

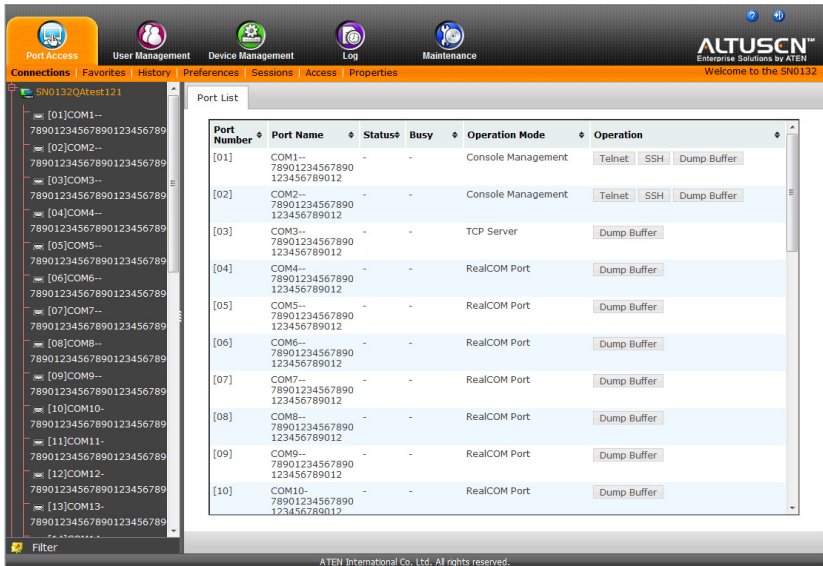

The *Connections* page is organized into several main areas. All the devices, ports, and outlets that a user is permitted to access are listed in the Sidebar at the left of the page. In addition to Serial Console Server device listings, if any PDU / PON (Power Over the Net™) devices are connected to the Serial Console Server they are listed separately below the port listings.

After selecting a port in the Sidebar, clicking entries on the menu bar opens information and configuration pages related to the item selected in the Sidebar.

The Sidebar

All connected Serial Console Servers, port devices and PDU devices – including their ports and outlets – are listed in a tree structure in the Sidebar at the left of the screen:

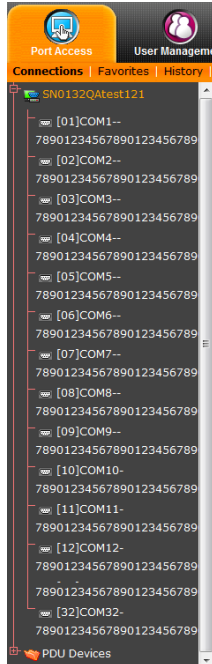

The Sidebar Tree Structure

The characteristics of the Sidebar tree structure are:

- ◆ Users are only allowed to see the devices and ports that they have access permission for.
- ◆ Ports are highlighted in blue when they are accessed by a user:

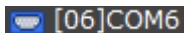

- ◆ Ports/outlets and child devices can be nested under their parent devices. Click the + in front of a device to expand the tree and see the ports/outlets nested underneath it. Click the - to collapse the tree and hide the nested ports/outlets.

Filter

The *Filter* allows you to control the number and type of ports that display in the Sidebar. When you click Filter, the bottom of the panel changes to look similar to the image, below:

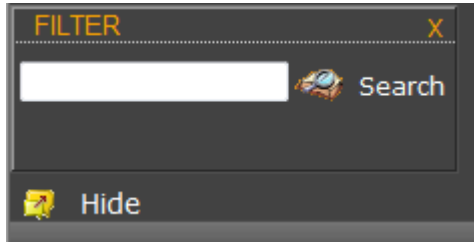

The meanings of the choices are explained in the following table:

Choices	Explanation
Search	<p>If you key in a search string and click Search, only port names that match the search string display in the tree. Wildcards (? for single characters; * for multiple characters) and the keyword or are supported, so that more than one port can show up in the list.</p> <p>For example:</p> <ol style="list-style-type: none"> 1. If you key in Web*, both Web Server 1 and Web Server 2 show up in the list. 2. If you key in W*1 or M*2, both Web Server 1 and Mail Server 2 show up in the list.

Connections

The main panel on the *Connections* page displays the *Port List*. From here you can select and connect to the serial devices via the port they are connected to.

Port Number	Port Name	Status	Busy	Operation Mode	Operation	Port
[01]	COM1-- 789012345678901 23456789012	-	-	Console Management Direct	Telnet SSH Dump Buffer	5001/5101
[02]	COM2-- 789012345678901 23456789012	-	-	TCP Client	Dump Buffer	-
[03]	COM3-- 789012345678901 23456789012	-	-	TCP Client	Dump Buffer	-
[04]	COM4-- 789012345678901 23456789012	-	-	RealCOM Port	Dump Buffer	5200/5201
[05]	COM5-- 789012345678901 23456789012	-	-	RealCOM Port	Dump Buffer	5200/5201
[06]	COM6-- 789012345678901 23456789012	-	-	RealCOM Port	Dump Buffer	5200/5201
[07]	COM7-- 789012345678901 23456789012	-	-	RealCOM Port	Dump Buffer	5200/5201
[08]	COM8-- 789012345678901 23456789012	-	-	RealCOM Port	Dump Buffer	5200/5201
[09]	COM9-- 789012345678901 23456789012	-	-	RealCOM Port	Dump Buffer	5200/5201
[10]	COM10-- 789012345678901	-	-	RealCOM Port	Dump Buffer	5200/5201

Heading	Description
Port Number	This column represents the physical port that the device is connected to on the rear of the Serial Console Server.
Port Name	This column shows the port name which can be changed from the <i>Port Access - Properties</i> page (See page 69 for details).
Status	This column shows the On or Off status of a device connected to the port. If no device is connected to the port a “-” will appear. A status of None indicates <i>Online Detect</i> has been disabled for the port, and no information is being provided about the port or device (See <i>Online Detect</i> , page 70 for details).
Busy	This column will show Busy when the port is being accessed by a user through the Serial Console Server.
Operation Mode	This column lists the Work Mode that the port is set to for access. The most common setting is <i>Console Management</i> , which is set on the <i>Port Access - Properties</i> page, under the <i>Operation Mode</i> tab (See <i>Operating Mode</i> , page 72 for details). Note: Console Management is the means of accessing a serial device for operations on it.

Heading	Description
Operation	Lists Console Management access methods: Telnet and SSH for managing a port device. Clicking either one opens the SNViewer application to manage that serial device (See <i>Telnet/SSH</i> , page 61, below). Dump Buffer : This button allows you to dump and view the buffer log of activity conducted on the device. Click to save the log. (See <i>Save & Copy</i> , page 70 for details).
Port	Shows the respective Telnet and SSH Port number configured for access to the serial device (See <i>Service Ports</i> , page 94 for details).

Telnet/SSH

To access a serial device connected to the Serial Console Server, click the port's **Telnet** or **SSH** button from the *Port Access - Connections* page:

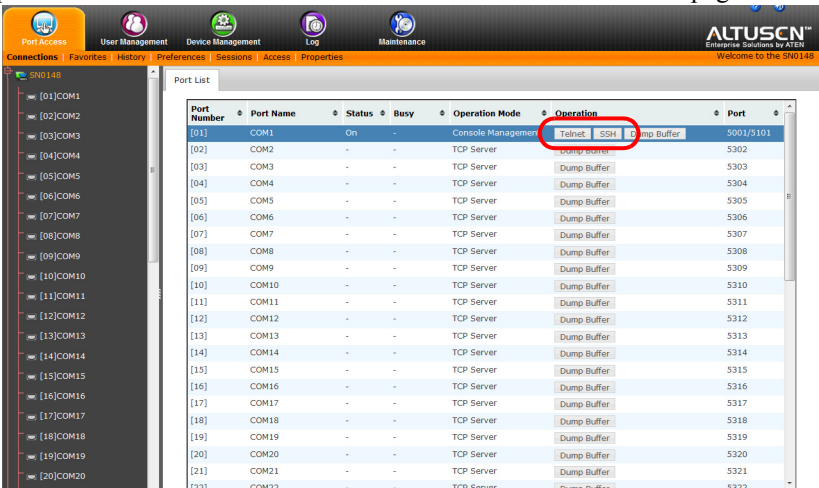

The Serial Console Server opens *SNViewer* to start your session with the serial device, and a screen similar to the one below appears:

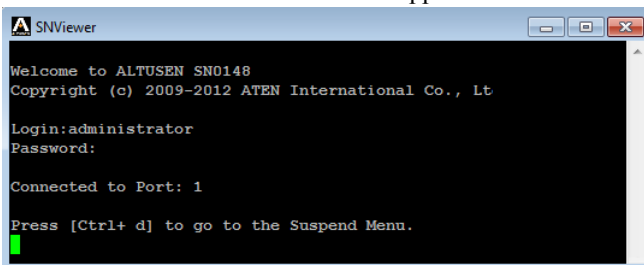

From the *SNViewer* you can login and perform management activities on the serial device. For more information on using the *SNViewer*, see *SNViewer*, page 45 for details.

Port Attributes

Clicking a device on the sidebar from the *Port Access - Connections* page brings up the **Port Attributes** page with detailed information about the device and Power Over the Net™ reboot options, as shown here:

The screenshot displays the 'Port Attributes' page. At the top, there is a tab labeled 'Port Attributes'. Below this, a table lists the port's status and configuration:

Status	
Port ID:	COM1
Port Name:	COM1
BaudRate:	9600
Parity:	None
DataBits:	8 bits
StopBits:	1 bit
FlowControl:	None
Work Mode:	Console Management
Port Buffering:	memory

Below the table, there is an 'Associate Link' section with the following text: 'Power Supply Associate : OutletA@STATION_04_0108:1'. To the right of this text is a small icon of a power outlet with a lightning bolt, and a 'Reboot' button with a square icon.

At the bottom of the page, there are three buttons: 'Telnet', 'SSH', and 'Dump Buffer'.

From here you can use the **Telnet**, **SSH**, and **Dump Buffer** buttons at the bottom of the page, or reboot a device connected to an associated Power Over the Net™ PDU. For information on associating PON devices, see *Association*, page 113 for details.

Favorites

The *Favorites* tab allows you to keep all the connections that you access most frequently in one convenient place. To add a port to Favorites, right-click on it from the sidebar and select **Add to Favorites**, or select a port and click **Add**. The layout and functions available on the Favorites tab are exactly the same as those found on the Port List tab (See *Connections*, page 60 for details).

ID	Port Number	Port Name	Status	Busy	Operation Mode	Operation
01	[01]	COM1-- 7890123456789 0123456789012	-	-	Console Management	Telnet SSH Dump Buffer
02	[03]	COM3-- 7890123456789 0123456789012	-	-	TCP Server	Dump Buffer
03	[05]	COM5-- 7890123456789 0123456789012	-	-	RealCOM Port	Dump Buffer

History

The History page provides a record of each time that a port was accessed. It provides quick access to the most recently used ports. You can access a port shown in the main panel by clicking its **Telnet** or **SSH** button.

Port Number	Port Name	Status	Busy	Operation Mode	Time	Operation
[06]	COM6-- 7890123456789 0123456789012	-	-	RealCOM Port	03/08/2000 20:38:02	Dump Buffer
[07]	COM7-- 7890123456789 0123456789012	-	-	RealCOM Port	03/08/2000 20:39:30	Dump Buffer
[02]	COM2-- 7890123456789 0123456789012	-	-	Console Management	09/12/2012 02:22:32	Telnet SSH Dump Buffer
[01]	COM1-- 7890123456789 0123456789012	-	-	Console Management	09/12/2012 04:21:52	Telnet SSH Dump Buffer
[03]	COM3-- 7890123456789 0123456789012	-	-	TCP Server	09/12/2012 04:22:02	Dump Buffer

- ◆ If there are more entries than there is room on the screen, a scroll bar appears to let you scroll up and down to see the entire record.
- ◆ To clear the record, click the *Delete* button at the bottom right of the page.
- ◆ You can change the sort order by clicking the column headings.

Preferences

The *Preferences* page allows users to set up their own, individual, working environments. The Serial Console Server stores a separate configuration record for each user profile, and sets up the working configuration according to the *Username* that was keyed into the Login dialog box:

Preferences

Language:

Logout Timeout: min (0-30)

Broadcast Timeout: sec (0-240)

Viewer: Auto Detect Java Client

Welcome Message: Enabled User Name

Broadcast Ports

COM1 COM2 COM3 COM4 COM5 COM6

COM7 COM8 COM9 COM10 COM11 COM12

COM13 COM14 COM15 COM16 COM17 COM18

COM19 COM20 COM21 COM22 COM23 COM24

COM25 COM26 COM27 COM28 COM29 COM30

COM31 COM32

Old Password:

New Password:

Confirm Password:

The page settings are explained in the following table:

Setting	Function
Language	Select the language that the web GUI uses.
Logout Timeout	If there is no user input for the amount of time set with this function, the user is automatically logged out. Once logged out, a login is necessary before the Serial Console Server can be accessed again.
Broadcast Timeout	If there is no user input for the amount of time set here, the Broadcast function is automatically ended. Key in a value from 0–240 seconds. A setting of 0 (zero) has the same effect as disabling the function. For more information on the Broadcast function, see <i>Broadcast Ports</i> within this table.

Setting	Function
Viewer	<p>You can choose which viewer is used when accessing a serial device:</p> <ul style="list-style-type: none">◆ Auto Detect will select the appropriate viewer based on the web browser used; WinClient for Windows Internet Explorer, Java Client for other web browsers (ex. Firefox).◆ Java Client will open the Java based viewer regardless of the web browser being used.
Welcome Message	<p>You can choose to hide or show the <i>Welcome Message</i> and/or <i>User Name</i> displayed in the submenu bar. The default is disabled.</p>
Broadcast Ports	<p>Select the ports to receive broadcast commands by selecting the boxes. Selecting Broadcast Ports allows you to access and make changes on a single port and the same change will be made across all Broadcast Ports.</p> <p>Note: For broadcasting to work, you must access a Broadcast Port using the SNViewer and turn Broadcast on from the Control Panel (See <i>Control Panel Functions</i>, page 46).</p>
Save	<p>Click Save to save any changes made to the Preferences settings.</p>
Changing a Password	<ul style="list-style-type: none">◆ In the Browser GUI, to change a user's password, key in the old password and new password into their input boxes; key the new password into the <i>Confirm</i> input box, then click Change Password to apply the change.

Sessions

The *Session* page lets the administrator and users with User Management permissions see at a glance which users are currently logged into the Serial Console Server, and provides information about each of their sessions.

Select	Username	Service	IP	Login Time	Last Access	User Type
<input type="checkbox"/>	administrator	HTTP	10.3.41.141	10/01/2012 15:58:19	10/01/2012 15:58:28	Super Administrator

- Note:**
1. The Session page isn't available for ordinary users.
 2. Users with User Management permissions can only see the sessions of ordinary users.
 3. The sort order of the information displayed can be changed by clicking the column headings.















The meanings of the headings at the top of the page are fairly straightforward.

Heading	Description
Username	Refers to the user that logged in.
Service	Displays the type of session (HTTP, HTTPS) established to login.
IP	Refers to the IP address that the user has logged in from.
Login Time	Indicates the date and time the user logged in.
Last Access	Indicates when the user last accessed the system for use.
User Type	Lists the type of user who has logged in: SA (Super Administrator), Administrator (Administrator), or Normal user (User).

This page also gives the administrator the option of forcing a user logout by checking the **Select** box for the user and clicking **Kill Session** at the bottom of the main panel.

Access

Administrators use the *Access* page to set user and group access and configuration rights for Serial Console Server ports and PDU devices. The Access page only appears for those users with User Management permissions and isn't available for other users. Access rights can be set on a user-by-user or a group-by-group basis. See *User Management*, page 75, to setup groups and users.

Users	No Access	View Only	Full Access	Config	Power Supply
 1234567890123456789012	<input checked="" type="radio"/>	<input type="radio"/>	<input type="radio"/>	<input type="checkbox"/>	<input type="checkbox"/>
 2	<input type="radio"/>	<input type="radio"/>	<input checked="" type="radio"/>	<input checked="" type="checkbox"/>	<input checked="" type="checkbox"/>
 3	<input checked="" type="radio"/>	<input type="radio"/>	<input type="radio"/>	<input type="checkbox"/>	<input type="checkbox"/>
 4	<input checked="" type="radio"/>	<input type="radio"/>	<input type="radio"/>	<input type="checkbox"/>	<input type="checkbox"/>
 7	<input checked="" type="radio"/>	<input type="radio"/>	<input type="radio"/>	<input type="checkbox"/>	<input type="checkbox"/>
 88	<input checked="" type="radio"/>	<input type="radio"/>	<input type="radio"/>	<input type="checkbox"/>	<input type="checkbox"/>
 b	<input type="radio"/>	<input type="radio"/>	<input checked="" type="radio"/>	<input checked="" type="checkbox"/>	<input checked="" type="checkbox"/>
 c	<input checked="" type="radio"/>	<input type="radio"/>	<input type="radio"/>	<input type="checkbox"/>	<input type="checkbox"/>
 kvmuser	<input checked="" type="radio"/>	<input type="radio"/>	<input type="radio"/>	<input type="checkbox"/>	<input type="checkbox"/>
 notshadow-radius	<input type="radio"/>	<input type="radio"/>	<input checked="" type="radio"/>	<input checked="" type="checkbox"/>	<input checked="" type="checkbox"/>
 rrrrrrrrrrrrrrrrrrr	<input checked="" type="radio"/>	<input type="radio"/>	<input type="radio"/>	<input type="checkbox"/>	<input type="checkbox"/>
 sn1148-radius	<input type="radio"/>	<input type="radio"/>	<input checked="" type="radio"/>	<input checked="" type="checkbox"/>	<input checked="" type="checkbox"/>
 ug1	<input checked="" type="radio"/>	<input type="radio"/>	<input type="radio"/>	<input type="checkbox"/>	<input type="checkbox"/>
 ug3	<input checked="" type="radio"/>	<input type="radio"/>	<input type="radio"/>	<input type="checkbox"/>	<input type="checkbox"/>

Use the radio buttons to configure access rights on the *User Access* and *Group Access* page. The meaning of the columns are given in the table, below:

User Access	Each User created on the Serial Console Server (excluding Super Administrator accounts) is listed to set access and configuration rights for each device listed on the sidebar. Select a device from the Sidebar to set the access and configuration rights of each User.
Group Access	Each Group created on the Serial Console Server is listed to set access and configuration rights for each device listed on the sidebar. Select a device from the Sidebar to set the access and configuration rights of each Group.

Access Rights	The Access columns are where access rights are set. The meaning of each is explained below.	
	Full Access	The user can view the device and can perform operations on the device.
	View Only	The user can only view the device; he cannot perform any operations on it.
	No Access	The device will not show up on the User's list on the Main Screen.
Config	Sets or denies permission for the user to make changes to a port's configuration settings. A check mark (<input checked="" type="checkbox"/>) indicates that the user has permission; an empty box means that the user does not have permission.	
Power Supply	This column permits/restricts the configuration and power operation of ports that have Power Over the Net™ devices connected to them. A check mark (<input checked="" type="checkbox"/>) indicates that the user has permission; an empty box means that the user does not have permission.	

Properties

When you click the Properties tab, the *Port Settings List* page appears:

Port Number	Port Name	Operation Mode	Properties
[01]	COM1	Console Management	9600,N,8,1,None
[02]	COM2	Console Management	9600,N,8,1,None
[03]	COM3	Console Management	9600,N,8,1,None
[04]	COM4	Console Management	9600,N,8,1,None
[05]	COM5	Console Management	9600,N,8,1,None
[06]	COM6	Console Management	9600,N,8,1,None
[07]	COM7	Console Management	9600,N,8,1,None
[08]	COM8	Console Management	9600,N,8,1,None
[09]	COM9	Console Management	9600,N,8,1,None
[10]	COM10	Console Management	9600,N,8,1,None
[11]	COM11	Console Management	9600,N,8,1,None
[12]	COM12	Console Management	9600,N,8,1,None
[13]	COM13	Console Management	9600,N,8,1,None
[14]	COM14	Console Management	9600,N,8,1,None
[15]	COM15	Console Management	9600,N,8,1,None
[16]	COM16	Console Management	9600,N,8,1,None
[17]	COM17	Console Management	9600,N,8,1,None
[18]	COM18	Console Management	9600,N,8,1,None
[19]	COM19	Console Management	9600,N,8,1,None
[20]	COM20	Console Management	9600,N,8,1,None
[21]	COM21	Console Management	9600,N,8,1,None
[22]	COM22	Console Management	9600,N,8,1,None
[23]	COM23	Console Management	9600,N,8,1,None
[24]	COM24	Console Management	9600,N,8,1,None
[25]	COM25	Console Management	9600,N,8,1,None
[26]	COM26	Console Management	9600,N,8,1,None

When a port is double clicked from the *Port Settings List* or from the *Sidebar*, the **Properties** page appears and looks similar to the one below:

Properties	Port Buffering	Operation Mode
Port ID:	COM1	
Port Name:	COM1	
Baud Rate:	9600	
Parity:	None	
Data Bits:	8 bits	
Stop Bits:	1 bit	
Flow Control:	None	
Toggle DTR:	<input checked="" type="checkbox"/> Enabled	
Online Detect:	<input checked="" type="checkbox"/> Enabled	
<input type="button" value="Save&Copy"/> <input type="button" value="Save"/> <input type="button" value="Back"/>		

This panel allows you to make configuration settings for the selected port, as explained in the table below:

Setting	Meaning
Port ID	Each port on the Serial Console Server has a port ID number. The value in this field indicates the port that is being configured.

Setting	Meaning
Port Name	You can give a port an appropriate name by editing the <i>Port Name</i> field.
Baud Rate	This sets the port's data transfer speed. Choices are from 300–115200 (drop down the list to see all options). Set this to match the baud rate setting of the connected device. Default is 9600 (which is a default setting for many serial devices).
Data Bits	This sets the number of bits used to transmit one character of data. Choices are: 5, 6, 7 and 8. Set this to match the data bit setting of the connected device. Default is 8 (which is a default setting for many serial devices).
Parity	This bit checks the integrity of the transmitted data. Choices are: None; Odd; Even; Mark; Space. Set this to match the parity setting of the connected device. Default is None (which is a default setting for many serial devices).
Stop Bits	This indicates that a character has been transmitted. Set this to match the stop bit setting of the connected device. Choices are: 1, 1.5, and 2. Default is 1 (which is a default setting for many serial devices).
Flow Control	This allows you to choose how the data flow will be controlled. Choices are: None, Hardware (RTS/CTS), and XON/XOFF. Set this to match the flow control setting of the connected device. Default is None.
Toggle DTR	Enabling this parameter allows the DTR signal to toggle between enabled and disabled. A check mark (<input checked="" type="checkbox"/>) enables Toggle DTR.
Online Detect	This allows you to set the DSR signal to detect the online status of each port. If Online Detect is disabled, the <i>Status</i> column on the <i>Port Access - Connections</i> page will always show as None for the port, providing no indication of the port or device status.

Save & Copy

At the bottom right side of each Properties page you can click *Save* to save the settings for the selected port, or *Save&Copy* which allows you to copy and save the current port settings for any/all other ports, as shown here:

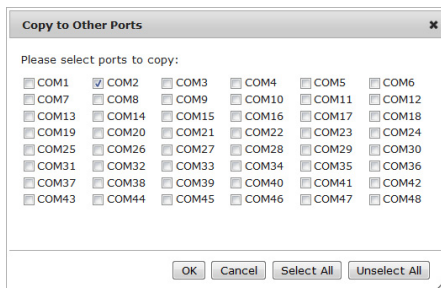

Simply select the ports you want to save the current setting to and click **OK**.

Port Buffering

Port Buffering creates a log of activity conducted when a port is accessed. You can save the log to memory on the Serial Console Server, or to a USB device. A USB device provides more storage space, while the Serial Console Server is limited to its internal memory.

To enable Port Buffering, from the drop-down menu: select *Memory*, or select a mounted USB drive. Select *Disable* to disable Port Buffering. Use the check box to enable/disable *Time Stamps*.

The screenshot shows a configuration window with three tabs: 'Properties', 'Port Buffering', and 'Operation Mode'. The 'Port Buffering' tab is active. It contains two settings: 'Port Buffering:' with a dropdown menu set to 'memory', and 'Time Stamps:' with a checked checkbox and the text 'Enabled'.

If you selected a mounted USB device, additional information is provided:

This screenshot shows the configuration window with the 'Port Buffering' dropdown set to 'usb1'. Below this, the 'External Storage Status' section is expanded, showing 'Mount Status:' as 'Mounted' with a 'Mount' button, and 'Buffer File Name:' as 'bufdat1'. The 'Time Stamps:' checkbox remains checked and labeled 'Enabled'.

The *Buffer File Name* allows you to customize the file name of the log saved to the USB device. If the USB drive isn't mounted, you can click **Mount** to mount the device for access.

Operating Mode

The Operation Mode page allows you to configure settings for access and management of each port. This determines how each serial device is accessed via operating modes.

- ◆ **Operating Mode** – This sets the mode you use to access the port device for management. The most common setting is **Console Management**, which allows for Telnet/SSH sessions from the *Port Access - Connections* page. Select the port's work mode from the drop-down menu.

Note: See *Port Operating Modes*, **page 53**, for full details of the different port operating modes that are available from the drop-down list.

◆ General Settings

Properties Port Buffering **Operating Mode**

Operating Mode: **Console Management** ▼

▼ General Settings

Max Sessions:

Suspend Character:

Access Mode: ▼

Occupy Timeout: sec

Exit Macro:

Connection Protocol: SSH Telnet

CRLF Translation: Enabled

▶ Alert Strings

▶ Command Filters

Setting	Meaning
Max Sessions	Set the maximum number of concurrent sessions here.
Suspend Character	The Suspend character is used to bring up the Suspend Menu in Telnet sessions. Valid characters are A–Z, except H, I, J, and M - which may not be used.

Setting	Meaning
Access Mode	<p>Defines how the port is to be accessed when multiple users have logged on, as follows:</p> <p>Exclusive: The first user to access the port has exclusive control over the port. No other users can view the port. The <i>Timeout</i> function does not apply to ports which have this setting.</p> <p>Occupy: The first user to access the port has control over the port. However, additional users may view the port. If the user who controls the port is inactive for longer than the time set in the <i>Timeout</i> box, port control is transferred to the next user who makes a change on the system.</p> <p>Share: Users simultaneously share control over the port. Input from the users is placed in a queue and executed chronologically.</p>
Occupy Timeout	If there is no input on this port for the amount of time set with this function, the port is released for use by another user.
Exit Macro	Set the Exit Macro here. You can create a macro that will execute when exiting the serial device.
Connection Protocol	Use the check boxes to enable/disable SSH and Telnet connection protocols.
CRLF Translation	This allows you to select whether to send a Carriage Return and Line Feed signal (CRLF).

◆ Alert Stings

The Port *Alert Strings* dialog box provides a way for you to be informed about problems that occur on the devices connected to the Serial Console Server's ports.

▼ Alert Strings

Enable Alert String

Alert String1:

Alert String2:

Alert String3:

Alert String4:

Alert String5:

Alert String6:

Alert String7:

Alert String8:

Alert String9:

Alert String10:

When a device has a problem – such as a critical error that requires a reboot, or an SNMP Trap event has been triggered – debug messages can be sent through its serial port to the Serial Console Server's COM port.

When the Serial Console Server receives such a message, it can send an SNMP Trap alert and/or an email to inform the user specified here of the problem. You can specify up to 10 types of alerts.

After setting up this page, whenever one of the specified alerts is generated, you will be informed of its occurrence.

◆ **Command Filters**

<input checked="" type="checkbox"/> Enable Command Filter	
Command Filter1:	<input type="text" value="ls"/>
Command Filter2:	<input type="text" value="dir"/>
Command Filter3:	<input type="text" value="pwd"/>
Command Filter4:	<input type="text"/>
Command Filter5:	<input type="text"/>
Command Filter6:	<input type="text"/>
Command Filter7:	<input type="text"/>
Command Filter8:	<input type="text"/>
Command Filter9:	<input type="text"/>
Command Filter10:	<input type="text"/>
Command Filter11:	<input type="text"/>
Command Filter12:	<input type="text"/>
Command Filter13:	<input type="text"/>
Command Filter14:	<input type="text"/>
Command Filter15:	<input type="text"/>

On this page you can specify up to 16 command filters.

Chapter 7

User Management

Overview

When you select the *User Management* tab the screen comes up with the *Accounts* page displayed:

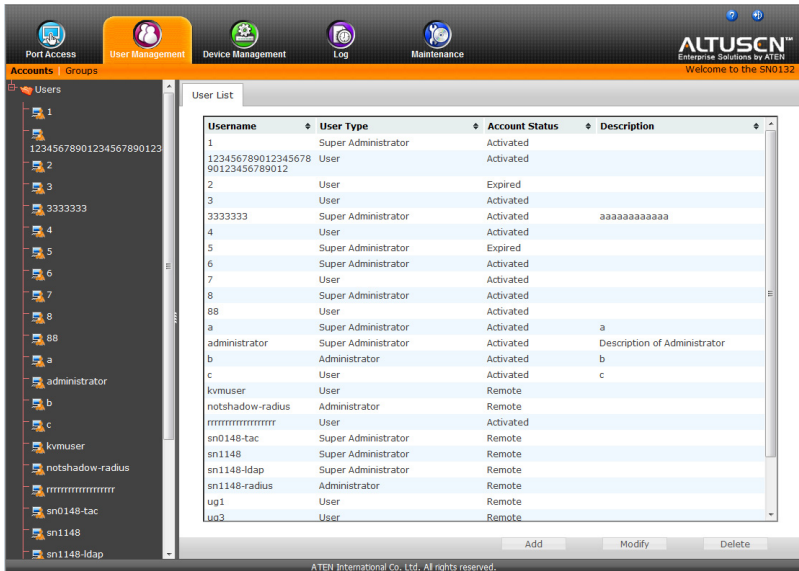

The page is organized into two main areas: the Sidebar at the left, and the large main panel at the right.

- ◆ Users and groups appear in the panel at the left of the page. The large panel at the right provides more detailed information at-a-glance for each.
 - ◆ The Browser GUI has separate menu bar entries for Accounts (Users) and Groups. Depending on the menu item selected, either Users or Groups are listed in the Sidebar.
- ◆ In the Browser GUI, the sort order of the information displayed can be changed by clicking the main panel column headings.
- ◆ The buttons below the main panel are used to manage users and groups, as shown in the sections that follow.

Users

The Serial Console Server supports three user types, as shown in the table below:

User Type	Role
Super Administrator	Access and manage ports and devices. Manage Users, and Groups. Configure the overall installation. Configure personal working environment.
Administrator	Access and manage authorized ports and devices. Manage Users and Groups. Configure personal working environment.
User	Access authorized ports and devices. Manage authorized ports and devices; configure personal working environment. Note: Users who have been given permission to do so, may also manage other users.

Adding Users

To add a user, and assign user permissions, do the following:

1. Select *Users* in the Sidebar.
2. Click **Add** at the bottom of the main panel. The User notebook opens, with the *User* tab selected:

The screenshot shows the 'User' configuration form with the following details:

- General:** Username, Password, Confirm Password, Description, and Local User (checked).
- Role:** Super Administrator, Administrator, and User (selected).
- Permissions:** Device Admin, User Admin, Maintenance Admin, Logs Admin, PDU User, Broadcast User, and View Only User.
- Status:** Disable account, Account never expires (selected), Account expires on: (with a date field), User must change password at next logon, User cannot change password, and Password never expires (checked).

3. Enter the required information in the appropriate fields. A description of each of the fields is given in the table below:

Field	Description
Username	From 1 to16 characters are allowed depending on the Account Policy settings. See <i>Account Policy</i> , page 112.
Password	From 0 to16 characters are allowed depending on the Account Policy settings. See <i>Account Policy</i> , page 112.
Confirm Password	To be sure there is no mistake in the password, you are asked to enter it again. The two entries must match.
Description	Additional information about the user that you may wish to include.
Role	<p>There are three categories: Super Administrator, Administrator and User. There is no limitation on the number of accounts that can be created in each category.</p> <ul style="list-style-type: none"> ◆ The Super Administrator is responsible for the overall installation configuration and maintenance; user management; and device and port assignments. The Super Administrator's permissions are automatically assigned by the system and cannot be altered. ◆ The Administrators default permissions include everything except <i>Device Admin</i> and <i>User Admin</i>, but the permissions can be altered for each Administrator by checking or unchecking any of the permissions checkboxes. ◆ The Users default permissions include <i>PDU User</i> and <i>Broadcast User</i>, but the permissions can be altered for each User by checking or unchecking any of the permissions checkboxes.
Permissions	<ul style="list-style-type: none"> ◆ Enabling <i>Device Admin</i> allows a user to configure and control the settings for overall Serial Console Server operations (see <i>Device Management</i>, page 91). ◆ Enabling <i>User Admin</i> allows a user to create, modify, and delete user and group accounts. ◆ Enabling <i>Maintenance Admin</i> allows a user to perform all the Maintenance operations available under the Maintenance tab (see <i>Maintenance</i>, page 123). ◆ Enabling <i>Logs Admin</i> allows a user to access the system log (see <i>Log</i>, page 119). ◆ Enabling <i>PDU User</i> allows users to configure Power Over the Net™ devices ◆ Enabling <i>Broadcast User</i> allows the use of Broadcasting ◆ Enabling <i>View Only User</i> limits users to only being able to view the display of connected devices. They cannot control port access, nor can they input any keyboard or mouse signals to the devices they view.

Field	Description
Status	<p>Status allows you to control the user's account and access to the installation, as follows:</p> <ul style="list-style-type: none"> ◆ <i>Disable Account</i> lets you suspend a user's account without actually deleting it, so that it can be easily reinstated in the future. ◆ If you don't want to limit the time scope of the account, select <i>Account never expires</i>; if you do want to limit the amount of time that the account remains in effect, select <i>Account expires on</i>, and key in the expiration date. ◆ To require a user to change his password at the next logon, select <i>User must change password at next logon</i>. This can be used by the administrator to give the user a temporary password to log in for the first time, and then let the user set the password of his choice for future logins. ◆ To make a password permanent, so that the user cannot change it to something else, select <i>User cannot change password</i>. ◆ For security purposes, administrators may want users to change their passwords from time to time. <ul style="list-style-type: none"> ◆ If not, select <i>Password never expires</i>. This allows users to keep their current passwords for as long as they like. ◆ If so, select <i>Password expires after</i>, and key in the number of days allowed before the password expires. Once the time is up, a new password must be set.

4. At this point you can assign the new user to a group by selecting the *Groups* tab – the *Groups* page is discussed on page 83. You can also assign the user's port access rights by selecting the *Devices* tab – the *Devices* page is discussed on page 87.

Note: Optionally, you can skip this step now to add more users and create groups, and come back to it later.

5. When your selections have been made click **Save**.
6. When the *Operation Succeeded* message appears, click **OK**.

7. Click **Users** in the Sidebar to return to the main screen. The new user appears in the Sidebar list and in the main panel, as well.
 - ♦ The Sidebar *Users* list can expand and collapse. If the list is expanded, click the minus symbol (–) next to the *Users* icon to collapse it; if it is collapsed there is a plus symbol (+) next to the icon. Click the plus symbol to expand it.
 - ♦ The icon for super administrators has two black bands; the icon for administrators has one red band.
 - ♦ The large main panel shows the user’s name; the description that was given when the account was created; and whether the account is currently active or has been disabled.

Modifying User Accounts

To modify a user account, do the following:

1. In the Sidebar *User* list, click the user’s name
– or –
In the main panel, select the user’s name
2. Click **Modify**.
3. In the *User* page that comes up, make your changes, then click **Save**.

Note: The *User* page is discussed on page 76; the *Groups* page is discussed on page 83, the *Devices* page is discussed on page 87.

Deleting User Accounts

To delete a user account do the following:

1. In the main panel, select the user’s name.
2. Click **Delete**.
3. Click **OK**.

Groups

Groups allow administrators to easily and efficiently manage users and devices. Since device access rights apply to anyone who is a member of the group, administrators need only set them once for the group, instead of having to set them for each user individually. Multiple groups can be defined to allow some users access to specific devices, while restricting other users from accessing them.

Creating Groups

To create a group, do the following:

1. Select *Groups* on the menu bar.
2. Click **Add** at the bottom of the main panel. The Group notebook opens, with the *Group* tab selected:

The screenshot shows a web application interface for creating a group. At the top, there are three tabs: "Group", "Members", and "Devices". The "Group" tab is selected. Below the tabs is a form with three main sections:

- General:** Contains two text input fields labeled "Group name:" and "Description:".
- Permissions:** Contains six checkboxes arranged in two rows:
 - Row 1: Device Admin, User Admin, Maintenance Admin
 - Row 2: Logs Admin, PDU User, Broadcast User
 - Row 3: View Only User
- Status:** Contains three radio buttons:
 - Disable group
 - Group never expires
 - Group expires on: [text input field]

At the bottom right of the form, there are two buttons: "Save" and "Back".

3. Enter the required information in the appropriate fields. A description of each of the fields is given in the table below:

Field	Description
Group Name	A maximum of 16 characters is allowed.
Description	Additional information about the user that you may wish to include. A maximum of 63 characters is allowed.
Permissions	Permissions and restrictions for groups are set by checking the appropriate boxes. These are the same permissions as the ones specified for Users. See <i>Permissions</i> , page 77 for details

4. At this point you can assign users to the group by selecting the *Members* tab – the Members page is discussed on page 85. You can also assign the group’s port access rights by selecting the *Devices* tab – the Devices page is discussed on page 87.

Note: Optionally, you can skip this step now to add more groups and assign users to them, and come back to it later.

5. When your selections have been made click **Save**.
6. When the *Operation Succeeded* message appears, click **OK**.
7. Click **Group** in the Sidebar to return to the main screen. The new group appears in the Sidebar Group list and in the main panel.
- ◆ The Sidebar *Group* list can expand and collapse. If the list is expanded, click the minus symbol (–) next to the *Users* icon to collapse it; if it is collapsed there is a plus symbol (+) next to the icon. Click the plus symbol to expand it.
 - ◆ The large main panel shows the group’s name, and the description that was given when the group was created

Repeat the above procedure to add additional groups.

Note: You must perform Step 7 before attempting to add a new group, or else the new group you are creating will replace the group you just finished creating.

Modifying Groups

To modify a group, do the following:

1. In the Sidebar *Group* list, click the group's name
– or –
In the main panel, select the group's name.
2. Click **Modify**.
3. In the *Group* notebook that comes up, make your changes, then click **Save**.

Note: The *Group* page is discussed on page 80; the *Members* page is discussed on page 85, The *Devices* page is discussed on page 87.

Deleting Groups

To delete a group do the following:

1. In the Sidebar, click the *Groups* icon.
2. In the main panel, select the group's name.
3. Click **Delete**.
4. Click **OK**.

Users and Groups

There are two ways to manage users and groups: from the Users notebook; and from the Group notebook.

Note: Before you can assign users to groups, you must first create them. See *Adding Users*, page 76 for details.

Assigning Users to a Group From the User's Notebook

To assign a user to a group from the User's notebook, do the following:

1. In the Sidebar *User* list, click the user's name
– or –
In the main panel, select the user's name
2. Click **Modify**.
3. In the *User* notebook that comes up, select the *Groups* tab. A screen, similar to the one below, appears:

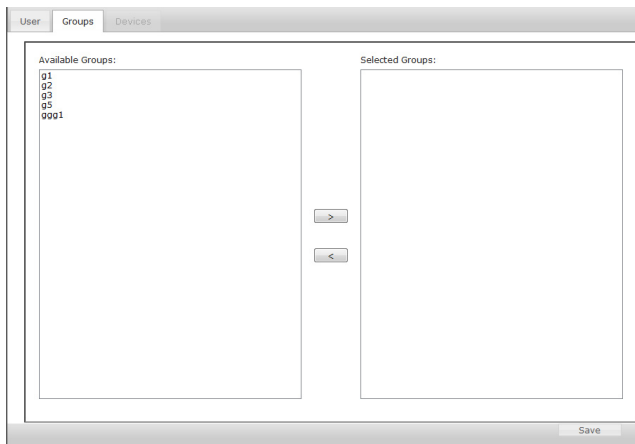

4. In the *Available* column, select the group that you want the user to be in.
5. Click the **Right Arrow** to put the group's name into the *Selected* column.
6. Repeat the above for any other groups that you want the user to be in.
7. Click **Save** when you are done.

Note: If a user has permissions in addition to the ones assigned to the group, the user keeps those permissions in addition to the group ones.

Removing Users From a Group From the User's Notebook

To remove a user from a group from the User's notebook, do the following:

1. In the Sidebar *User* list, click the user's name
– or –
In the main panel, select the user's name.
2. Click **Modify**.
3. In the *User* notebook that comes up, select the *Groups* tab. A screen, similar to the one below, appears:

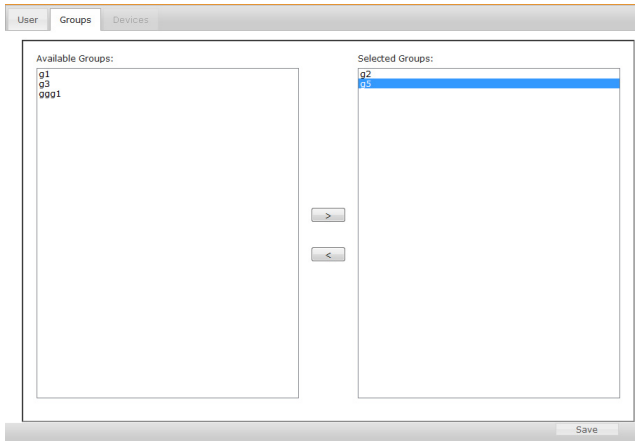

4. In the *Selected* column, select the group that you want to remove the user from.
5. Click the **Left Arrow** to remove the group's name from the *Selected* column. (It goes back into the *Available* column.)
6. Repeat the above for any other groups that you want to remove the user from.
7. Click **Save** when you are done.

Assigning Users to a Group From the Group's Notebook

To assign a user to a group from the Group notebook, do the following:

1. In the Sidebar *Group* list, click the group's name
– or –
In the main panel, select the group's name.
2. Click **Modify**.
3. In the *Group* notebook that comes up, select the *Members* tab. A screen, similar to the one below, appears:

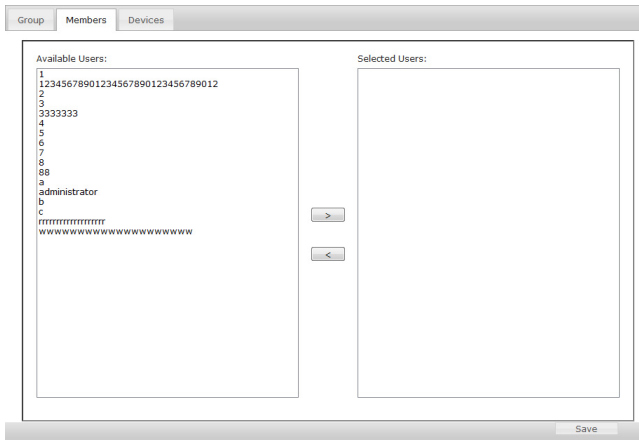

4. In the *Available* column, select the user that you want to be a member of the group.
5. Click the **Right Arrow** to put the user's name into the *Selected* column.
6. Repeat the above for any other users that you want to be members of the group.
7. Click **Save** when you are done.

Note: If a user has permissions in addition to the ones assigned to the group, the user keeps those permissions in addition to the group ones.

Removing Users From a Group From the Group's Notebook

To remove a user from a group from the Group's notebook, do the following:

1. In the Sidebar *Group* list, click the group's name
 – or –
 In the main panel, select the group's name.
2. Click **Modify**.
3. In the *Group* notebook that comes up, select the *Members* tab. A screen, similar to the one below, appears:

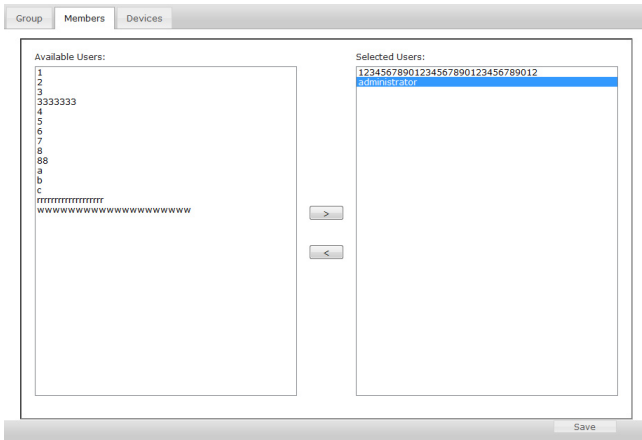

4. In the *Selected* column, select the user that you want to remove from the group.
5. Click the **Left Arrow** to remove the user's name from the *Selected* column. (It goes back into the *Available* column.)
6. Repeat the above for any other users that you want to remove from the group.
7. Click **Save** when you are done.

Device Assignment

When a user logs in to the Serial Console Server, the interface comes up with the Port Access page displayed. All the ports that the user is permitted to access are listed in the Sidebar at the left of the page. Access permissions for those ports and the devices connected to them are assigned on a port-by-port basis from the *User* or *Group* list on the Sidebar of the User Management page.

Assigning Device Permissions From the User's Notebook

To assign a device permissions to a user from the *User's* notebook, do the following:

1. In the Sidebar *User* list, click the user's name

– or –

In the main panel, select the user's name.

2. Click **Modify**.
3. In the *User* notebook that comes up, select the *Devices* tab. A screen, similar to the one below, appears:

Port Name	No Access	View Only	Full Access	Config	Power Supply
SNO132QAtest121 [01]COM1-- 7890123456789012345678901 2	<input checked="" type="radio"/>	<input type="radio"/>	<input type="radio"/>	<input type="checkbox"/>	<input type="checkbox"/>
[02]COM2-- 7890123456789012345678901 2	<input checked="" type="radio"/>	<input type="radio"/>	<input type="radio"/>	<input type="checkbox"/>	<input type="checkbox"/>
[03]COM3-- 7890123456789012345678901 2	<input checked="" type="radio"/>	<input type="radio"/>	<input type="radio"/>	<input type="checkbox"/>	<input type="checkbox"/>
[04]COM4-- 7890123456789012345678901 2	<input checked="" type="radio"/>	<input type="radio"/>	<input type="radio"/>	<input type="checkbox"/>	<input type="checkbox"/>
[05]COM5-- 7890123456789012345678901 2	<input checked="" type="radio"/>	<input type="radio"/>	<input type="radio"/>	<input type="checkbox"/>	<input type="checkbox"/>
[06]COM6-- 7890123456789012345678901 2	<input checked="" type="radio"/>	<input type="radio"/>	<input type="radio"/>	<input type="checkbox"/>	<input type="checkbox"/>
[07]COM7-- 7890123456789012345678901 2	<input checked="" type="radio"/>	<input type="radio"/>	<input type="radio"/>	<input type="checkbox"/>	<input type="checkbox"/>
[08]COM8-- 7890123456789012345678901 2	<input checked="" type="radio"/>	<input type="radio"/>	<input type="radio"/>	<input type="checkbox"/>	<input type="checkbox"/>
[09]COM9-- 7890123456789012345678901 2	<input checked="" type="radio"/>	<input type="radio"/>	<input type="radio"/>	<input type="checkbox"/>	<input type="checkbox"/>
[10]COM10-- 7890123456789012345678901 2	<input checked="" type="radio"/>	<input type="radio"/>	<input type="radio"/>	<input type="checkbox"/>	<input type="checkbox"/>

Save

4. Make your permission settings for each port according to the information provided below:

Name: Each port accessible to the user is listed under the *Names* column.

Access: The *Access* column is where device access rights are set. Click the radio buttons in the rows that corresponds your choices. The meanings are described, below:

Full Access	The user can view the remote screen and can perform operations on the remote server from his keyboard.
View Only	The user can only view the remote screen; he cannot perform any operations on it.
No Access	No access rights - the Port will not show up on the User's list on the Main Screen.

Config: The *Config* column is where a user's permission to make changes to a port's configuration settings are permitted/restricted. A check mark () indicates that the user has permission to make changes to the port's configuration settings; an empty box means that the user is denied permission to make configuration changes.

Power Supply: The *Power Supply* column permits/restricts the configuration and power operation of ports that have Power Over the Net™ devices connected to them. A check mark () indicates that the user has permission; an empty box means that the user does not have permission.

5. When you have finished making your choices, click **Save**.
6. In the confirmation popup that appears, click **OK**.

Note: In any of the columns, you can use Shift-Click or Ctrl-Click to select a group of ports to configure. Clicking to cycle through the choices on any one of the selected ports causes all of them to cycle in unison.

Assigning Device Permissions From the Groups' Notebook

To assign a device permissions to a Group of users, do the following:

1. In the Sidebar *Groups* list, click the group's name
– or –
In the main panel, select the group's name.
2. Click **Modify**.
3. In the *Groups* notebook that comes up, select the *Devices* tab.
4. The screen that comes up is the same one that appears in the User's notebook. The only difference is that whatever settings you make apply to all members of the group instead of just one individual member.
Make your device assignments according to the information described under *Assigning Device Permissions From the User's Notebook*, page 87.

This Page Intentionally Left Blank

Chapter 8

Device Management

Devices

The Device Management page opens with the top level Serial Console Server selected in the Sidebar, with all its ports nested below, and the *Device Information* page displaying in the main panel:

Device Information

General

Device Name:

Description:

MFG: **xxx.xxx**

Network Interfaces:

bond0 MAC: 00107448002A
ipv4 addr: 10.3.42.178 Mask: 255.255.255.0

Power Supply Detection

Power 1 Status: On Power 2 Status: Off

Mounted Devices

NFS Settings

NFS Name	Source	Status	Auto	Operation
nfs1		N/A	<input type="checkbox"/>	<input type="button" value="Mount"/>
nfs2		N/A	<input type="checkbox"/>	<input type="button" value="Mount"/>
nfs3		N/A	<input type="checkbox"/>	<input type="button" value="Mount"/>
nfs4		N/A	<input type="checkbox"/>	<input type="button" value="Mount"/>

General

The *General* section of the Device Information page displays and allows you to set the **Device Name** and **Description** and view the **Manufacturing (MFG)** information of the Serial Console Server. The Network Interfaces section provides detailed information about its network configurations.

Note: The “MFG Number” (Manufacturing Number) is an internal serial number used by ATEN’s factory and technical support staff to identify products. This number does not affect products’ warranty. If your product requires after-sales services, you may provide the MFG Number to ATEN’s sales or technical support staff to identify the product and model number.

The SN0108A / SN0116A / SN0132 / SN0148 are designed with two power supplies. The Power Supply Detection section provides information about the two Serial Console Server's power supplies.

- ◆ The icons for Power Supply 1 and Power Supply 2 display in gray when there is no power to the power supply - they display in blue when power is present.
- ◆ When the *Power Supply Detection* function is enabled (there is a check in the checkbox), when there is only one source of power, the Serial Console Server will beep to warn you of the problem. The default for this function is enabled.

If you are at the Local Console you will see a message asking you to confirm that your intention is to only have one power source. If your intention is to only have one source of power, there are two ways to stop the beeping:

- 1) You can disable power supply warnings by unchecking the checkbox. Do this if you want to disable this function on a permanent basis.
- 2) You can confirm your intention in the dialog box. Do this if you only want to disable the warning temporarily. With this method, the warning function will be back in effect after the next system reset.

Mounted Devices

The *Mounted Devices* section displays information about USB and NFS storage devices connected for use. When a USB device is plugged into the front of the Serial Console Server (SN0108A / SN0116A / SN0132 / SN0148 only), or NFS storage locations are set (*see NFS Settings below*), they appear here with detailed information about the mounted device.

NFS Settings

NFS (Network File System) allows you to mount storage devices across the network. You can mount up to 4 devices. Fill in the **Source** with the storage devices network location (IP Address or Network Name) including the full path of the location you want to mount. Next, click **Mount** to mount the NFS storage device. The **Status** column indicates *N/A*, *Mounted*, or *Unmounted*. *Unmounted* shows if the storage device isn't accessible. If this happens make sure the device is accessible on the network, and check that the *Source* information you typed in is correct. Check **Auto** to auto mount the NFS.

Network

The Network page is used to specify the network environment.

Network Information

IP Installer
 Enabled View Only Disabled

Service Ports

HTTP Port: <input type="text" value="80"/>	HTTPS Port: <input type="text" value="443"/>
SSH Port: <input type="text" value="22"/>	Telnet Port: <input type="text" value="23"/>
Base Socket: <input type="text" value="5001"/>	

Network Configuration
 Enable Redundant NIC
 Select a network adapter:

IPv4 Configuration
 Obtain IP address automatically [DHCP]
 Set IP address manually [Fixed IP]
 IP Address
 Subnet Mask
 Default Gateway

 Obtain DNS server address automatically
 Set DNS server address manually
 Preferred DNS server
 Alternate DNS server

IPv6 Configuration
 Obtain IP address automatically [DHCP]
 Set IP address manually [Fixed IP]
 IP Address
 Prefix Length:
 Default Gateway

 Obtain DNS server address automatically
 Set DNS server address manually
 Preferred DNS server
 Alternate DNS server

Save

Each of the elements on this page is described in the sections that follow.

Note: The *Enable Redundant NIC* option is only available for SN0108A / SN0116A / SN0132 / SN0148 serial console servers.

IP Installer

The IP Installer is an external Windows-based utility for assigning IP addresses to the Serial Console Server.

Click one of the radio buttons to select *Enable*, *View Only*, or *Disabled* for the IP Installer utility. See *IP Installer*, page 139, for IP Installer details.

-
- Note:** 1. If you select *View Only*, you will be able to see the Serial Console Server in the IP Installer's Device List, but you will not be able to change the IP address.
2. For security, we strongly recommend that you set this to *View Only* or *Disable* after each use.
-

Service Ports

As a security measure, if a firewall is being used, the Administrator can specify the port numbers that the firewall will allow. If a port other than the default is used, users must specify the port number as part of the IP address when they log in. If an invalid port number (or no port number) is specified, the Serial Console Server will not be found. An explanation of the fields is given in the table below:

Field	Explanation
HTTP	The port number for a browser login. The default is 80.
HTTPS	The port number for a secure browser login. The default is 443.
SSH	The port for SSH access. The default is 22.
Telnet	The port for Telnet access. The default is 23.
Base Socket	The port used to listen for and accept a TCP connection

-
- Note:** 1. Valid entries for all of the Service Ports are from 1–65535.
2. Service ports cannot have the same value. You must set a different value for each one.
3. If there is no firewall (on an Intranet, for example), it doesn't matter what these numbers are set to, since they have no effect.
-

Network Configuration

- ◆ Redundant NIC*

The SN0108A / SN0116A / SN0132 / SN0148 are designed with two network interfaces. If *Enable Redundant NIC* is enabled (the default), both interfaces make use of the IP address of network adapter *eth0*.

Under this configuration, the second interface is usually inactive. If there is a network failure on the first interface, the Serial Console Server automatically switches to the second interface.

- ◆ Redundant NIC Enabled – Single IP Address for Both Interfaces

To enable the Redundant NIC function, do the following:

1. Click to put a check in the *Enable Redundant NIC* checkbox.
2. *eth0* is selected in the network adapter listbox, and the listbox is disabled – you cannot configure *eth1*.
3. Configure the IP and DNS server addresses for *eth0* (see the sections below).

- ◆ Redundant NIC Not Enabled – Two IP Addresses

If you choose not to enable the Redundant NIC function, the two NICs can be configured with separate interfaces. Users can log into the SN0132 / SN0148 with either IP address. To set up the Serial Console Server with this configuration, do the following:

1. If there is a check in the *Enable Redundant NIC* checkbox, click to remove it.
2. In the network adapter listbox; select *eth0*.
3. Configure the IP and DNS server addresses for *eth0* (see the sections below).
4. Drop down the network adapter listbox; select *eth1*.
5. Configure the IP and DNS server addresses for *eth1*.

Note: Only available for SN0108A / SN0116A / SN0132 / SN0148 devices. To configure SN9108 / SN9116 serial console servers, see *IPv4 Settings*, page 96.

- ◆ IPv4 Settings

- ◆ IP Address:

IPv4 is the traditional method of specifying IP addresses. The Serial Console Server can either have its IP address assigned dynamically (DHCP), or it can be given a fixed IP address.

- ◆ For dynamic IP address assignment, select the *Obtain IP address automatically* radio button. (This is the default setting.)
 - ◆ To specify a fixed IP address, select the *Set IP address manually* radio button and fill in the fields with values appropriate for your network.

Note: 1. If you choose *Obtain IP address automatically*, when the unit starts up it waits to get its IP address from the DHCP server. If it hasn't obtained the address after one minute, it automatically reverts to its factory default IP address (192.168.0.60 / 61.)

2. If the unit is on a network that uses DHCP to assign network addresses, and you need to ascertain its IP address, see *IP Address Determination*, page 139, for information./

- ◆ DNS Server

- ◆ For automatic DNS Server address assignment, select the *Obtain DNS Server address automatically* radio button.
 - ◆ To specify the DNS Server address manually, select the *Set DNS server address manually* radio button, and fill in the addresses for the Preferred and Alternate DNS servers with values appropriate for your network.

Note: Specifying the Alternate DNS Server address is optional.

- ◆ IPv6 Settings

- ◆ IP Address:

- IPv6 is the new (128-bit) format for specifying IP addresses. (See *IPv6*, page 141 for further information.) The Serial Console Server can either have its IPv6 address assigned dynamically (DHCP), or it can be given a fixed IP address.

- ◆ For dynamic IP address assignment, select the *Obtain IP address automatically* radio button. (This is the default setting.)
 - ◆ To specify a fixed IP address, select the *Set IP address manually* radio button and fill in the fields with values appropriate for your network.

- ◆ DNS Server

- ◆ For automatic DNS Server address assignment, select the *Obtain DNS Server address automatically* radio button.
 - ◆ To specify the DNS Server address manually, select the *Set DNS server address manually* radio button, and fill in the addresses for the Preferred and Alternate DNS servers with values appropriate for your network.

Note: Specifying the Alternate DNS Server address is optional.

ANMS

The ANMS (Advanced Network Management Settings) page is used to set up login authentication and authorization management from external sources. It is organized as a notebook with three tabs – each with a series of related panels, as described, below:

Event Destination

The screenshot shows the 'Event Destination' configuration page with three tabs: 'Event Destination', 'Authentication & Authorization', and 'CC Management'. The 'SMTP Settings' panel is expanded, displaying the following configuration:

- Enable report from the following SMTP Server
- SMTP Server: 10.0.92.132
- SMTP Port: 25
- My server requires authentication
- Account Name: jack
- Password: [masked]
- From: jack@qatest.mail
- To: jack@qatest.mail

Below the SMTP settings, there are four collapsed panels: Log Server, SNMP Settings, SysLog Settings, and SMS Settings.

◆ SMTP Settings

To have the Serial Console Server email reports from the SMTP server to you, do the following:

1. Enable the *Enable report from the following SMTP server*, and key in either the IPv4 address, IPv6 address, or domain name of the SMTP server.
2. Key in the SMTP port.
3. If your server requires authentication, put a check in the *My server requires authentication* checkbox, and key in the appropriate account information in the *Account Name* and *Password* fields.
4. Key in the email address of where the report is being sent from in the *From* field.

Note: 1. Only one email address is allowed in the *From* field, and it cannot exceed 64 Bytes.

2. 1 Byte = 1 English alphanumeric character.

5. Key in the email address (addresses) of where you want the SMTP reports sent to in the *To* field.

Note: If you are sending the report to more than one email address, separate the addresses with a semicolon. The total cannot exceed 256 Bytes.

◆ Log Server

Important transactions that occur on the Serial Console Server, such as logins and internal status messages, are kept in an automatically generated log file.

- ◆ To enable this, put a check in the *Enable report from the following Log Server* checkbox.
- ◆ Specify the MAC address of the computer that the Log Server runs on in the *MAC address* field.
- ◆ Specify the port used by the computer that the Log Server runs on to listen for log details in the *Service Port* field. The valid port range is 1–65535. The default port number is 9001.

Note: The port number must be different than the one used for the *Program* port.

◆ SNMP Server

▼ SNMP Settings

Enable SNMP Agent

Community for Read:

Enable SNMP Trap

1. Trap Receiver :
Receiver Port:
Community :

2. Trap Receiver :
Receiver Port:
Community :

3. Trap Receiver :
Receiver Port:
Community :

4. Trap Receiver :
Receiver Port:
Community :

Enable SNMP V3

SNMP V3 Account:
SNMP V3 Password:

Up to four SNMP management stations can be specified. If you want to use SNMP trap notifications, do the following:

1. Check *Enable SNMP Trap* and key in the Community.
2. Key in the IP address(es) and the service port number(s) of the computer(s) to be notified of SNMP trap events. The valid port range is 1–65535. The default port number is 162.

Note: Make sure that the port number you specify here matches the port number used by the SNMP receiver computer.

3. Key in the community value(s) if required for the SNMP version.
- ◆ To use SNMP V3, do the following:
1. Check *Enable SNMP V3*.
 2. Key in the Community values.
 3. The client setting for the authorization protocol should only use SHA and AES-128 encryption.

- ◆ Syslog Server

To record all the events that take place on Serial Console Server and write them to a Syslog server, do the following:

1. Check *Enable*.
2. Key in either the IPv4 address, IPv6 address, or domain name of the Syslog server.
3. Key in the port number. The valid port range is 1-65535.

- ◆ SMS Settings

To receive notifications via SMS, do the following:

1. Check *Enable*.
2. Enter the telephone numbers for the *Message Center* and *SMS Receiver*.

Note: When you have made all your changes, remember to click *Save* at the bottom right corner of the page.

Authentication and Authorization

Event Destination	Authentication & Authorization	CC Management
<div style="border: 1px solid black; padding: 10px;"> <p>▼ RADIUS Settings</p> <p><input checked="" type="checkbox"/> Enable</p> <p>Preferred RADIUS Server: <input type="text" value="10.0.92.100"/></p> <p>Preferred RADIUS Service Port: <input type="text" value="1645"/></p> <p>Alternate RADIUS Server: <input type="text" value="a100.atenqav6.com"/></p> <p>Alternate RADIUS Service Port: <input type="text" value="1645"/></p> <p>Timeout: <input type="text" value="3"/> sec</p> <p>Retries: <input type="text" value="2"/></p> <p>Shared Secret(at least 6 Characters): <input type="text" value="testing123-1"/></p> <p>▶ LDAP/AD Settings</p> <p>▶ TACACS+ Settings</p> <p>▶ Kerberos</p> </div>		

◆ RADIUS Settings

To allow authentication and authorization for the Serial Console Server through a RADIUS server, do the following:

1. Check **Enable**.
2. Fill in the IP addresses and service port numbers for the Preferred and Alternate RADIUS servers. You can use the IPv4 address, the IPv6 address or the domain name in the IP fields.
3. In the *Timeout* field, set the time in seconds that the Serial Console Server waits for a RADIUS server reply before it times out.
4. In the *Retries* field, set the number of allowed RADIUS retries.
5. In the *Shared Secret* field, key in the character string that you want to use for authentication between the Serial Console Server and the RADIUS Server. A minimum of 6 characters is required.
6. On the RADIUS server, Users can be authenticated with any of the following methods:
 - ◆ Set the entry for the user as **su/xxxx**
Where *xxxx* represents the Username given to the user when the account was created on the Serial Console Server.
 - ◆ Use the same Username on both the RADIUS server and the Serial Console Server.

- ◆ Use the same Group name on both the RADIUS server and the Serial Console Server.
- ◆ Use the same Username/Group name on both the RADIUS server and the Serial Console Server.

In each case, the user's access rights are the ones assigned that were assigned when the User of Group was created on the Serial Console Server. (See *Adding Users*, page 76.)

◆ LDAP / LDAPS Authentication and Authorization Settings

To allow authentication and authorization for the Serial Console Server via LDAP / LDAPS, refer to the information in the table, below:

Item	Action
Enable	Put a check in the <i>Enable LDAP</i> or <i>Enable LDAPS</i> checkbox to allow LDAP / LDAPS authentication and authorization.
LDAP Server IP and LDAP Service Port	Fill in the IP address and port number for the LDAP or LDAPS server. <ul style="list-style-type: none"> ◆ You can use the IPv4 address, the IPv6 address or the domain name in the <i>LDAP Server</i> field. ◆ For LDAP, the default port number is 389; for LDAPS, the default port number is 636.
Alternate LDAP Server and Alternate LDAP Service Port	Fill in the IP address and port number for the alternate LDAP or LDAPS server. <ul style="list-style-type: none"> ◆ You can use the IPv4 address, the IPv6 address or the domain name in the <i>Alternate LDAP Server</i> field. ◆ For an <i>Alternate LDAP Service Port</i>, the default port number is 389; for an <i>Alternate LDAPS Service Port</i>, the default port number is 636.
Admin DN	Consult the LDAP / LDAPS administrator to ascertain the appropriate entry for this field. For example, the entry might look like this: ou=kn4132,dc=aten,dc=com
Admin Name	Key in the LDAP administrator's username.
Admin Password	Key in the LDAP administrator's password.
Search DN	Set the distinguished name of the search base. This is the domain name where the search starts for user names.
Timeout	Set the time in seconds that the Serial Console Server waits for an LDAP or LDAPS server reply before it times out.

On the LDAP / LDAPS server, Users can be authenticated with any of the following methods:

- ◆ With MS Active Directory schema.

Note: If this method is used, the LDAP schema for MS Active Directory must be extended. Without schema – Only the Usernames used on the Serial Console Server are matched to the names on the LDAP / LDAPS server. User privileges are the same as the ones configured on the Serial Console Server.

- ◆ Without schema – Only Groups in AD are matched. User privileges are the ones configured for the groups he belongs to on the Serial Console Server.
- ◆ Without schema – Usernames and Groups in AD are matched. User privileges are the ones configured for the User and the Groups he belongs to on the Serial Console Server.
- ◆ TACACS+ Settings
 - ◆ **Enable** TACACS+ and enter the following information:
 - ◆ Preferred TACACS+ Server
 - ◆ Preferred TACACS+ Service Port
 - ◆ Shared Secret 1
 - ◆ Alternate TACACS+ Server
 - ◆ Alternate TACACS+ Service Port
 - ◆ Shared Secret 2
- ◆ Kerberos
 - ◆ **Enable** Kerberos and enter the following information:
 - ◆ Kerberos Server
 - ◆ Kerberos Service Port
 - ◆ Kerberos Realm

CC Management Settings

To allow authorization for the Serial Console Server through a CC (Control Center) server, check *Enable* and fill in the CC Server's IP address and Service port in the appropriate fields. You can use the IPv4 address, the IPv6 address or the domain name in the *CC Server IP* field.

Note: If this function is enabled, PON devices do not appear in the Sidebar, even if they are configured on the Serial Console Server. This is because they are managed via the CC server.

OOBC

In case the Serial Console Server cannot be accessed with the usual LAN-based methods, it can be accessed via the Serial Console Server's modem port or one of the serial ports (SN9108 / SN9116) configured for a modem. To enable support for PPP (modem) operation, click to put a checkmark in the *Enable Out of Band Access* checkbox.

SN0108A / SN0116A / SN0132 / SN0148

The screenshot shows the OOBC configuration window for the specified models. It is divided into several sections:

- Console Port Settings:** Baud Rate (9600), Parity (None), Data Bits (8 bits), Stop Bits (1 bit), Flow Control (None).
- PPP Settings:** Includes an Initialization String field.
- Modem Settings:**
 - PPP Dial In Settings:**
 - Enable Dial In / Dial Back
 - Enable Dial Back
 - Fixed Dial Back Number
 - Flexible Dial Back (Allow the caller to set the callback number)
 - PPP Server: 192.168.0.2
 - PPP Client: 192.168.0.1
 - PPP Dial Out Settings:** Enable Dial Out
 - ISP Settings:** (Section header)

SN9108 / SN9116

The screenshot shows the OOBC configuration window for the SN9108 / SN9116 models. It is divided into several sections:

- Console Port Settings:** Port Number (COM1), Baud Rate (9600), Parity (None), Data Bits (8 bits), Stop Bits (1 bit), Flow Control (None).
- PON Settings:** Port Number (dropdown menu).
- Modem Settings:**
 - Port Number (dropdown menu)
 - Initialization String (text field)
 - PPP Dial In Settings:** Enable Dial In / Dial Back

Select the **Port Number** that the *Console*, *PON* and *Modem* is connected to on the rear of the SN9108 / SN9116.

Enable Dial Back

When you enable Out of Band Access, the *Enable Dial Back*, and *Enable Dial Out* functions become available, as described in the sections that follow. As an added security feature, if this function is enabled, the Serial Console Server disconnects the calls that dial in to it, and dials back to one of the entries specified in the table below:

Item	Action
Enable Fixed Number Dial Back	<p>If <i>Fixed Number Dial Back</i> is enabled, when there is an incoming call, the Serial Console Server hangs up the modem and dials back to the modem whose phone number is specified in the Phone Number field.</p> <p>Key the phone number of the modem that you want the Serial Console Server to dial back to in the <i>Phone Number</i> field.</p>
Enable Flexible Dial Back	<p>If <i>Flexible Dial Back</i> is enabled, the modem that the Serial Console Server dials back to doesn't have to be fixed. It can dial back to any modem that is convenient for the user, as follows:</p> <ol style="list-style-type: none"> 1. Key the password that the users must specify in the <i>Password</i> field. 2. When connecting to the Serial Console Server's modem, users specify the phone number of the modem that they want the Serial Console Server to dial back to as their Username, and specify the password set in the <i>Password</i> field for their password.

Enable Dial Out

For the dial out function, you must establish an account with an Internet Service Provider, and use a modem to dial up to your ISP account. An explanation of the Enable Dial Out items is given in the table below:

Item	Action
ISP Settings	Specify the telephone number, account name (username), and password that you use to connect to your ISP.

Item	Action
Dial Out Schedule	<p>This entry sets up the times you want the Serial Console Server to dial out over the ISP connection.</p> <ul style="list-style-type: none"> ◆ <i>Every</i> provides a listing of fixed times from every hour to every four hours. <ul style="list-style-type: none"> ◆ If you select <i>Every two hours</i> (for example), the Serial Console Server will start dialing out every two hours beginning at 00:00. ◆ If you don't want the Serial Console Server to dial out on a fixed schedule, select Never from the list. ◆ <i>Daily at</i> will dial out once a day at a specified time. Use the hh:mm format to specify the time. ◆ <i>PPP online time</i> specifies how long you want the ISP connection to last before terminating the session and hanging up the modem. A setting of zero means it is always on line.
Emergency Dial Out	<p>If the Serial Console Server gets disconnected from the network, or the network goes down, this function puts the Serial Console Server on line via the ISP dial up connection.</p> <ul style="list-style-type: none"> ◆ If you choose <i>PPP stays online until network recovery</i>, the PPP connection to the ISP will last until the network comes back up or the Serial Console Server reconnects to it. ◆ If you choose <i>PPP online time</i>, the connection to the ISP will terminate after the amount of time that you specify is up. A setting of zero means it is always on line.
Dial Out Mail Configuration	<p>This section provides email notification of problems that occur on the devices connected to the Serial Console Server's ports (see <i>SMTP Settings</i>, page 98).</p> <p>Note: This email notification differs from the one configured under <i>SMTP Settings</i>, page 98, in that it uses the ISP mail server rather than the internal company's mail server.</p> <ul style="list-style-type: none"> ◆ Key in the IPv4 address, IPv6 address, or domain name of your SMTP server in the SMTP Server IP Address field. ◆ Key in the email address of the person responsible for the SMTP server (or some other equally responsible administrator), in the Email From field. ◆ Key in the email address (addresses) of where you want the report sent to in the To field. If you are sending the report to more than one email address, separate the addresses with a comma or a semicolon. ◆ If your server requires a secure SSL connection, put a check in the <i>SMTP server requires secure connection (SSL)</i> checkbox ◆ If your server requires authentication, put a check in the <i>SMTP server requires authentication</i> checkbox, then key in the appropriate account name and password in the fields, below.

When you have finished making your settings on this page, click **Save**.

Security

The Security page is divided into 4 main panels, as described in the sections that follow.

Login Failures

For increased security, the Login Failures section allows administrators to set policies governing what happens when a user fails to log in successfully.

Login Failures

Login Fail Policy: Disable User Account IP Address Locked

Maximum Login Failures:

Lockout Period: min

To set Login Failures, check one of the Login Fail Policy checkboxes. The meanings of the entries are explained in the table below:

Entry	Explanation
Login Fail Policy	<p>This determines what happens when a user fails to login according to the security parameters that are set here. When a user exceeds the maximum login failures, you can set the Serial Console Server to:</p> <ul style="list-style-type: none"> ◆ Disable User Account ◆ IP Address Locked <p>The amount of time the policy takes effect is set in the Lockout Period.</p>
Maximum login Failures	This field sets the number of failed attempts a user is allowed before the Login Fail Policy is activated.
Lockout Period	Sets the amount of time the User Account is disabled or IP Address is Locked before access will be reactivated.

Note: If a Login Fail Policy is not enabled, users can attempt to log in an unlimited number of times with no restrictions. For security purposes, we recommend that you enable this function and enable the lockout policies.

FIPS 140-2

For increased security, you can check or uncheck the boxes to enable *FIPS 140-2* for cryptographic modules or *SSLv3* security features.

FIPS 140-2

Enable FIPS 140-2 Enable SSLv3

IP/MAC Filter

IP Filter

Disable Include Exclude

Add
Modify
Delete

MAC Filter

Disable Include Exclude

Add
Modify
Delete

◆ IP and MAC Filtering

IP and MAC Filters control access to the Serial Console Server based on the IP and/or MAC addresses of the client computers attempting to connect. A maximum of 100 IP filters and 100 MAC filters are allowed. If any filters have been configured, they appear in the IP Filter and/or MAC Filter list boxes.

To enable IP and/or MAC filtering, select one of the following radio buttons:

- ◆ If the **Include** button is selected, all the addresses within the filter are allowed access; all other addresses are denied access.
- ◆ If the **Exclude** button is selected, all the addresses within the filter are denied access; all other addresses are allowed access.

◆ Adding Filters

To add an IP filter, do the following:

1. Click **Add**. A dialog box appears:

IP Filter

Enter the IP address to add

OK Cancel

2. Key the IP address you want to filter.
3. After filling in the address, click **OK**.
4. Repeat these steps for any additional IP addresses you want to filter.

To add a MAC filter, do the following:

1. Click **Add**. A dialog box appears
 2. Specify the MAC address in the dialog box, then click **OK**.
 3. Repeat these steps for any additional MAC addresses you want to filter.
- ◆ **IP Filter / MAC Filter Conflict**

If there is a conflict between an IP filter and a MAC filter – in other words, if a computer’s address is allowed by one filter but blocked by the other – then the blocking filter takes precedence (the computer’s access is blocked).
 - ◆ **Modifying Filters**

To modify a filter, select it in the IP Filter or MAC Filter list boxes and click **Modify**. The Modify dialog box is similar to the Add dialog box. When it comes up, simply delete the old address(es) and replace it with the new one(s).
 - ◆ **Deleting Filters**

To delete a filter, select it in the IP Filter or MAC Filter list box and click **Delete**.

Account Policy

In the Account Policy section, system administrators can set policies governing usernames and passwords.

Account Policy

Minimum Username Length:

Minimum Password Length:

Password Must Contain At Least:

One Upper Case

One Lower Case

One Number

Password expiration

 Password expires after: day(s)

The meanings of the Account Policy entries are explained in the table below:

Entry	Explanation
Minimum Username Length	Sets the minimum number of characters required for a username. Acceptable values are from 1–16. The default is 6.
Minimum Password Length	Sets the minimum number of characters required for a password. Acceptable values are from 0–16. A setting of 0 means that no password is required. Users can login with only a Username. The default is 6.
Password Must Contain At Least	Checking any of these items requires users to include at least one uppercase letter, one lowercase letter or one number in their password. Note: This policy only affects user accounts created after this policy has been enabled, and password changes to existing user accounts. Users accounts created before this policy was enabled, and there is no change to the existing passwords, are not affected.
Password Expiration	Enter a value (in days) for all passwords to expire.

Association

The *Association* tab lets you make your power management settings, such as synchronizing on/off/reboot, with associated PON (Power Over the Net™) devices.

Power Management

The *Power Management* page is used to associate a PON outlet with a serial device's port on the Serial Console Server. Once an association has been made, the power status of the device attached to the port can be controlled from the *Port Access* page, rather than having to control the power status by opening a separate web session to the PON device.

The page is organized into three main sections, as described in the table, below:

Page Section	Description
PON Associate Settings	This section is where you associate the Power Over the Net™ PDU's power outlet(s) with a serial port on the Serial Console Server.
Outlet Settings	This section is where you set up the power management configuration for each outlet. Refer to the <i>Outlet Configuration</i> section of the Power Over the Net™ User Manual's <i>Administration</i> chapter for configuration details.
Schedule	This section is where you set up a scheduled Power On/Off configuration for an outlet. Refer to the <i>Schedule</i> section of the Power Over the Net™ User Manual's <i>Administration</i> chapter for setup details.

To associate a PON outlet with a serial port, from the *Power Management* page, do the following:

1. In the Sidebar tree, select the serial port you want to associate with the PON outlet.

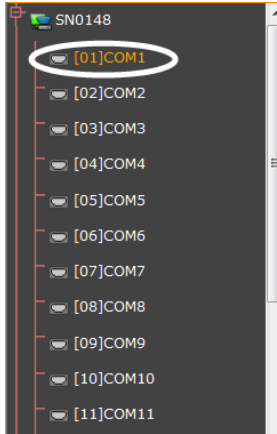

2. From the *PON Associate Settings*, click **Add**.

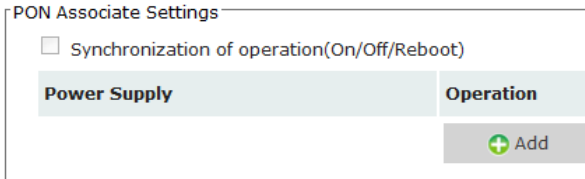

3. When a pop-up window appears, select the PON outlet that you want to associate with the serial port:

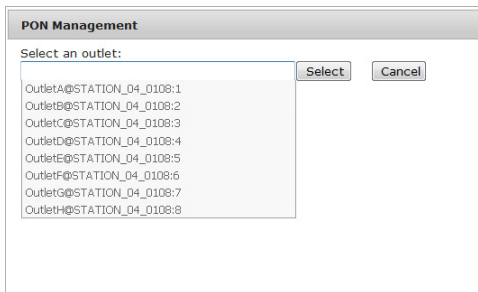

Note: This should be the PON outlet the serial device is plugged into on the PDU.

4. (Optional) If the device connected to the Serial Console Server's port has a dual power supply and you wish to associate additional outlets, simply click **Add** to select another outlet to associate with the port. You can associate up to four outlet ports to a connected device.
5. (Optional) If you have associated two or more power supply outlets and you want to synchronize the On/Off/Reboot operations for all power supplies, put a check mark in the *Synchronization of operation (ON/OFF/Reboot)* checkbox.
6. Set the *Outlet Setting* and *PON Schedule Settings* according to the information provided in the Connection and Schedule sections of the PN0108 User Manual's Administration chapter.
7. Click **Save**.

You can manage the configuration and schedule settings of the device by selecting its port from the *Device Management - Association* page; or by selecting the PDU's Outlet on the sidebar from the *Port Access - Connections* page.

Summary

Clicking the Summary tab brings up a page similar to the one below:

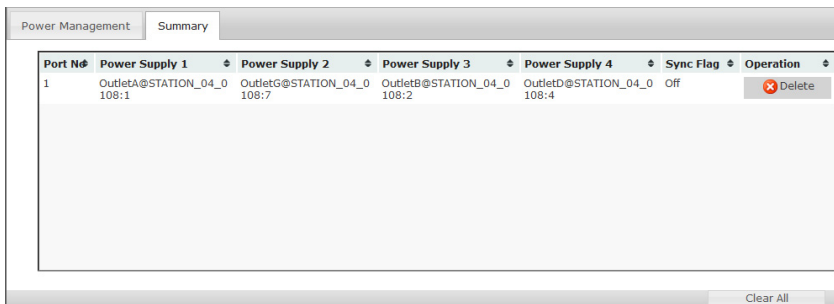

The screenshot shows a web interface with a 'Power Management' header and a 'Summary' tab. Below the header is a table with columns for 'Port No', 'Power Supply 1', 'Power Supply 2', 'Power Supply 3', 'Power Supply 4', 'Sync Flag', and 'Operation'. The table contains one row of data. A 'Delete' button with a red 'X' icon is visible next to the 'Operation' column. At the bottom right of the interface is a 'Clear All' button.

Port No	Power Supply 1	Power Supply 2	Power Supply 3	Power Supply 4	Sync Flag	Operation
1	OutletA@STATION_04_0 108:1	OutletG@STATION_04_0 108:7	OutletB@STATION_04_0 108:2	OutletD@STATION_04_0 108:4	Off	Delete

This page provides a sorted listing of the power associations that have been made via the Power Management page.

- ◆ You can change the sort order by clicking the column headings.
- ◆ To remove a power association, select it and click **Delete**.
- ◆ To remove all of the power associations, click **Clear All**.

Date/Time

The Date/Time dialog page sets the Serial Console Server time parameters:

Current System Time

Date (YYYY-MM-DD)

Time (HH:MM:SS)

New System Time

Synchronize with computer time

Date (YYYY-MM-DD)

Time (HH:MM:SS)

Set manually

Date (YYYY-MM-DD)

Time (HH:MM:SS)

Synchronize with NTP server

Using default NTP server.

Primary NTP Server

Alternate NTP Server

SN0148 Time Zone

Time Zone:

Set the parameters according to the information below.

Current System Time

This section displays the time and date that the switch is currently set to. The time and date fields are for information purposes and cannot be edited.

Note: In the Browser UI, the system time displays the time relative to the time zone that the web browser session originates from – not the time zone of the Switch. If the web browser session originates from a time zone that is different from the switch’s time zone, the time shown in the display will be different from the switch’s time.

New System Time

Use these fields to change the switch's time and date settings, as follows:

- ◆ To set the switch's time and date to match the time and date of the computer you are logged in to, select the Synchronize with computer time radio button.

Note: Your computer's time and date are displayed in the fields just below the heading. These fields are for information purposes only.

- ◆ To set the time and date to values of your choosing, select the **Set manually** radio button and key the settings into their appropriate fields using the *YYYY-MM-DD* and *HH:MM:SS* formats.
- ◆ To have the time automatically synchronized to a network time server, select the **Synchronize with NTP server** radio button:
 - ◆ If you want to use your network's default time server, put a check in the *Using default NTP server* checkbox.
 - ◆ If you want to specify a time server, make sure that the *Using default NTP server* checkbox is unchecked, then key in the IP address of the time server of your choice in the *Primary NTP Server* field. If you want to configure an alternate time server, key in the IP address of the time server in the *Alternate NTP Server* field.
 - ◆ Click **Save** to apply the changes.

Time Zone

- ◆ To establish the time zone that the Serial Console Server is located in, drop down the *Time Zone* list and choose the city that most closely corresponds to where it is located.
- ◆ Click **Save** to apply the changes.

This Page Intentionally Left Blank

Chapter 9

Log

Overview

The Serial Console Server logs all the events that take place on it. To view the contents of the log, click the *Log* tab. The device's System Log page appears:

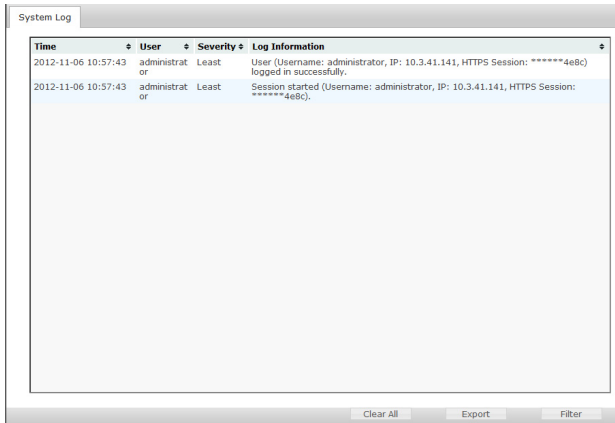

System Log

The System Log page displays events that take place on the Serial Console Server, and provides a breakdown of the time, the severity, the user, and a description of each one. You can change the sort order of the display by clicking on the column headings.

The log file tracks a maximum of 512 events. When the limit is reached, the oldest events get discarded as new events come in. The purpose of the buttons at the bottom of the page are described in the table:

Button	Explanation
Clear Log	Clicking <i>Clear Log</i> clears the log file.
Export Log	Clicking <i>Export Log</i> lets you save the contents of the log to a file on your computer.
Filter	Clicking <i>Filter</i> allows you to search for particular events by date or by specific words or strings, as described in the next section.

Filter

Filter lets you narrow the log event display to ones that occurred at specific times; ones containing specific words or strings; or ones involving specific users. When you access this function, the log filter dialog box appears at the bottom of the page:

A description of the filter items is given in the table, below:

Item	Description
Time	<p>This feature lets you filter for events that occurred at specific times, as follows:</p> <p>Today: Only the events for the current day are displayed.</p> <p>All: Select this radio button to filter results for all the records in the log file.</p> <p>Range: Select this radio button to filter results for records for a particular time period, then click the From and To fields and a calendar will appear for you to select the dates.</p>
Pattern	<p>Filters for a particular word or string. Key the word or string into the <i>Information</i> text box. Only events containing that word or string are displayed. Wildcards (? for single characters; * for multiple characters) and the keyword or are supported. E.g., h*ds would return hands and hoods; h?nd would return hand and hind, but not hard; h*ds or h*ks would return hands and hooks.</p>
User	<p>Filters for specific users. Key in the user's Username; then click Apply. Only events containing that Username are displayed.</p> <p>Note: If the <i>User</i> does not exist or the spelling is incorrect, no results will appear.</p>

Item	Description
Severity	<p>Filters based on the severity rating of the event. Least severe events appear in black; Less severe events appear in blue; Most severe events appear in red.</p> <p>Check the radio button for the severity level that you want to display: <i>All</i>, <i>Most</i>, <i>Less</i>, or <i>Least</i>.</p> <p>Only events that match the severity level you specified appear in the display.</p>
Apply	Click to apply the filter choices.
Reset	Click this button to clear the entries in the dialog box and start with a clean slate.
Cancel	Click this button to exit the log filter function without applying changes.

Log Notification Settings

The Notification Settings page lets you decide which events trigger a notification:



The notifications are grouped into five groups: You can choose to enable the following:

- ◆ All system events
- ◆ All authentication events
- ◆ All user management events
- ◆ All device management events
- ◆ All system task events

Chapter 10

Maintenance

Overview

The *Maintenance* function is used to upgrade firmware; backup and restore configuration and account information; and restore default values.

Backup / Restore

When you click on the *Maintenance* tab, it opens with the Backup/Restore page. This page gives you the ability to back up the Serial Console Server's configuration and user profile information:

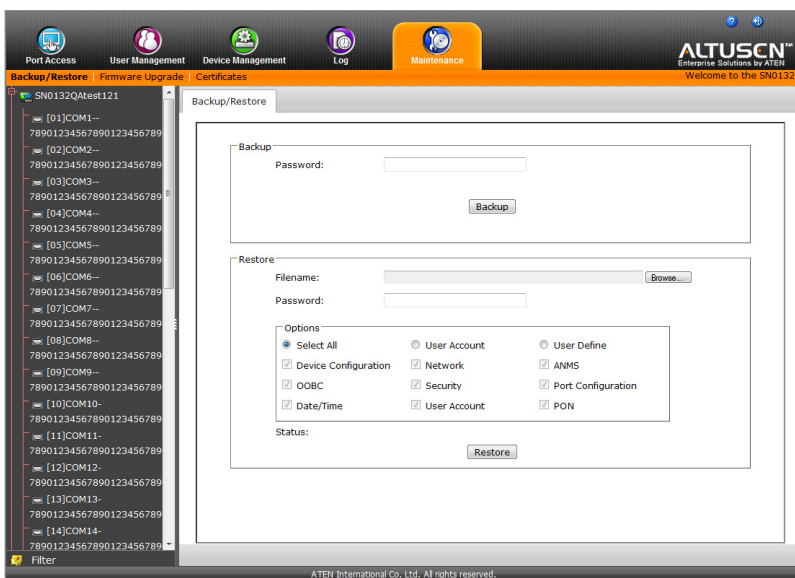

Backup

To backup the device's settings do the following:

1. In the *Password* field, key in a password for the file.

Note: 1. Setting a password is optional. If you do not set one, the file can be restored without specifying a password.

2. If you do set a password, make a note of it, since you will need it to be able to restore the file.
-

2. Click **Backup**.
3. When the browser asks what you want to do with the file, select *Save to disk*; then save it in a convenient location.

Restore

To restore a previous backup, do the following:

1. Click **Browse**; navigate to the file and select it.

Note: If you renamed the file, you can leave the new name. There is no need to return it to its original name.

2. If you set a password when you created the file, key it in the *Password* field.
3. Select as many of the options that are presented as you wish to restore.
4. Click **Restore**.

After the file is restored, a message appears to inform you that the procedure succeeded.

Firmware Upgrade

This page can be used to upgrade the Serial Console Server's firmware. As new versions of the firmware become available, they can be downloaded from our website. Check the website regularly to find the latest information and packages.

To upgrade the main firmware, do the following:

1. Download the new firmware file to your computer.
2. Log in to the Serial Console Server and click the *Maintenance* tab. Then, open the *Firmware Upgrade* page:

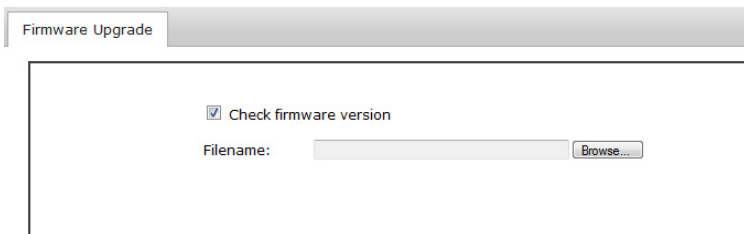

Firmware Upgrade

Check firmware version

Filename:

3. Click **Browse**; navigate to the directory that the new firmware file is in and select the file.
4. Click **Upgrade Firmware** to start the upgrade procedure.
 - ◆ If you enabled *Check Firmware Version* the current firmware level is compared with that of the upgrade file. If the current version is equal to or higher than the upgrade version, a popup message appears, to inform you of the situation and stops the upgrade procedure.
 - ◆ If you didn't enable *Check Firmware Version*, the upgrade file is installed without checking what its level is.
 - ◆ As the upgrade proceeds, progress information is shown in the *Progress* bar.
 - ◆ Once the upgrade completes successfully, the Serial Console Server resets itself.
5. Log in again, and check the firmware version to be sure it is the new one.

Certificates

This page provides information on the Private Certificates:

Private Certificate	
Name	Description
Issued To	
Common Name(CN)	ATEN INTERNATIONAL CO.,LTD
Organization(O)	ATEN INTERNATIONAL CO.,LTD
Organization Unit (OU)	R&D
Country(C)	TW
State or Province (ST)	Taiwan
Locality (L)	Shijr/Taipei
Email Address (E)	eservice@aten.com.tw
Serial Number	8B46B083DB8A8480
Issued By	
Common Name(CN)	ATEN INTERNATIONAL CO.,LTD
Organization(O)	ATEN INTERNATIONAL CO.,LTD
Organization Unit (OU)	R&D

New Get CSR Import Restore Defaults

Private Certificate

When logging in over a secure (SSL) connection, a signed certificate is used to verify that the user is logging in to the intended site. For enhanced security, the *Private Certificate* section allows you to use your own private encryption key and signed certificate, rather than the default ATEN certificate.

There are two methods for establishing your private certificate: generating a self-signed certificate; and importing a third-party certificate authority (CA) signed certificate.

- ◆ **Generating a Self-Signed Certificate**

If you wish to create your own self-signed certificate, a free utility – `openssl.exe` – is available for download over the web.

- ◆ **Obtaining a CA Signed SSL Server Certificate**

For the greatest security, we recommend using a third party certificate authority (CA) signed certificate. To obtain a third party signed certificate, go to a CA (Certificate Authority) website to apply for an SSL certificate. After the CA sends you the certificate and private encryption key, save them to a convenient location on your computer.

- ◆ Importing the Private Certificate

To import the private certificate, do the following:

1. Click **Import** from the bottom of the Private Certificate page, shown here:



2. Click **Browse** to the right of *Certificate Filename*; and browse to where your certificate file is located; and select it.
3. Click **Import** to complete the procedure.

Note: Clicking **Restore Defaults** returns the device to using the default ATEN certificate.

Certificate Signing Request

The Certificate Signing Request (CSR) section provides an automated way of obtaining and installing a CA signed SSL server certificate.



To perform this operation do the following:

1. Click **New**. The following dialog box appears:

2. Fill in the form – with entries that are valid for your site – according to the example information in the following table:

Information	Example
Country (2 letter code)	TW
State or Province	Taiwan
Locality	Taipei
Organization	Your Company, Ltd.
Unit	Tech Department
Common Name	mycompany.com Note: This must be the exact domain name of the site that you want the certificate to be valid for. If the site's domain name is <i>www.mycompany.com</i> , and you only specify <i>mycompany.com</i> , the certificate will not be valid.
Email Address	administrator@yourcompany.com

3. After filling in the form (all fields are required), click **Create**.

A self-signed certificate based on the information you just provided is now stored on the CCVSR.

4. Click Get CSR, and save the certificate file (*csr.cer*) to a convenient location on your computer.
This is the file that you give to the third party CA to apply for their signed SSL certificate.
5. After the CA sends you the certificate, save it to a convenient location on your computer.
6. Click **Import** from the lower menu bar and the *Private Certificate* window pops up, as shown here:

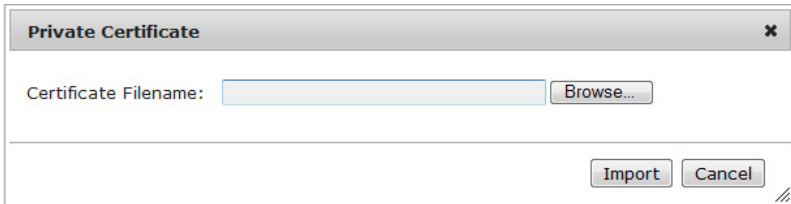

7. Click **Browse** to locate the certificate and select it as the *Certificate Filename*; then click **Import** to store it on the Serial Console Server.

Note: When you upload the file, the Serial Console Server checks the file to make sure the specified information still matches. If it does, the file is accepted; if not, it is rejected.

If you want to remove the certificate (to replace it with a new one because of a domain name change, for example), simply click **Restore Defaults**.

This Page Intentionally Left Blank

Safety Instructions

General

- ◆ This product is for indoor use only.
- ◆ Read all of these instructions. Save them for future reference.
- ◆ Follow all warnings and instructions marked on the device.
- ◆ Do not place the device on any unstable surface (cart, stand, table, etc.). If the device falls, serious damage will result.
- ◆ Do not use the device near water.
- ◆ Do not place the device near, or over, radiators or heat registers.
- ◆ The device cabinet is provided with slots and openings to allow for adequate ventilation. To ensure reliable operation, and to protect against overheating, these openings must never be blocked or covered.
- ◆ The device should never be placed on a soft surface (bed, sofa, rug, etc.) as this will block its ventilation openings. Likewise, the device should not be placed in a built in enclosure unless adequate ventilation has been provided.
- ◆ Never spill liquid of any kind on the device.
- ◆ Unplug the device from the wall outlet before cleaning. Do not use liquid or aerosol cleaners. Use a damp cloth for cleaning.
- ◆ The device should be operated from the type of power source indicated on the marking label. If you are not sure of the type of power available, consult your dealer or local power company.
- ◆ To prevent damage to your installation it is important that all devices are properly grounded.
- ◆ The device is designed for IT power distribution systems with 230V phase-to-phase voltage.
- ◆ The device is equipped with a 3-wire grounding type plug. This is a safety feature. If you are unable to insert the plug into the outlet, contact your electrician to replace your obsolete outlet. Do not attempt to defeat the purpose of the grounding-type plug. Always follow your local/national wiring codes.
- ◆ Do not allow anything to rest on the power cord or cables. Route the power cord and cables so that they cannot be stepped on or tripped over.

- ◆ If an extension cord is used with this device make sure that the total of the ampere ratings of all products used on this cord does not exceed the extension cord ampere rating. Make sure that the total of all products plugged into the wall outlet does not exceed 15 amperes.
- ◆ To help protect your system from sudden, transient increases and decreases in electrical power, use a surge suppressor, line conditioner, or un-interruptible power supply (UPS).
- ◆ Position system cables and power cables carefully; Be sure that nothing rests on any cables.
- ◆ When connecting or disconnecting power to hot-pluggable power supplies, observe the following guidelines:
 - ◆ Install the power supply before connecting the power cable to the power supply.
 - ◆ Unplug the power cable before removing the power supply.
 - ◆ If the system has multiple sources of power, disconnect power from the system by unplugging all power cables from the power supplies.
- ◆ Never push objects of any kind into or through cabinet slots. They may touch dangerous voltage points or short out parts resulting in a risk of fire or electrical shock.
- ◆ Do not attempt to service the device yourself. Refer all servicing to qualified service personnel.
- ◆ If the following conditions occur, unplug the device from the wall outlet and bring it to qualified service personnel for repair.
 - ◆ The power cord or plug has become damaged or frayed.
 - ◆ Liquid has been spilled into the device.
 - ◆ The device has been exposed to rain or water.
 - ◆ The device has been dropped, or the cabinet has been damaged.
 - ◆ The device exhibits a distinct change in performance, indicating a need for service.
 - ◆ The device does not operate normally when the operating instructions are followed.
- ◆ Only adjust those controls that are covered in the operating instructions. Improper adjustment of other controls may result in damage that will require extensive work by a qualified technician to repair.

Rack Mounting

- ◆ Before working on the rack, make sure that the stabilizers are secured to the rack, extended to the floor, and that the full weight of the rack rests on the floor. Install front and side stabilizers on a single rack or front stabilizers for joined multiple racks before working on the rack.
- ◆ Always load the rack from the bottom up, and load the heaviest item in the rack first.
- ◆ Make sure that the rack is level and stable before extending a device from the rack.
- ◆ Use caution when pressing the device rail release latches and sliding a device into or out of a rack; the slide rails can pinch your fingers.
- ◆ After a device is inserted into the rack, carefully extend the rail into a locking position, and then slide the device into the rack.
- ◆ Do not overload the AC supply branch circuit that provides power to the rack. The total rack load should not exceed 80 percent of the branch circuit rating.
- ◆ Make sure that all equipment used on the rack – including power strips and other electrical connectors – is properly grounded.
- ◆ Ensure that proper airflow is provided to devices in the rack.
- ◆ Ensure that the operating ambient temperature of the rack environment does not exceed the maximum ambient temperature specified for the equipment by the manufacturer
- ◆ Do not step on or stand on any device when servicing other devices in a rack.

Technical Support

International

- ◆ For online technical support – including troubleshooting, documentation, and software updates: **<http://support.aten.com>**
- ◆ For telephone support, see *Telephone Support*, page iv

North America

Email Support		support@aten-usa.com
Online Technical Support	Troubleshooting Documentation Software Updates	http://www.aten-usa.com/support
Telephone Support		1-888-999-ATEN ext 4988

When you contact us, please have the following information ready beforehand:

- ◆ Product model number, serial number, and date of purchase.
- ◆ Your computer configuration, including operating system, revision level, expansion cards, and software.
- ◆ Any error messages displayed at the time the error occurred.
- ◆ The sequence of operations that led up to the error.
- ◆ Any other information you feel may be of help.

Specifications

SN0108A / SN0116A

Function		SN0108A	SN0116A
Serial Connections		8	16
Connectors	Serial	8 x RJ45 Female (Black)	16 x RJ45 Female (Black)
	LAN	2 x RJ-45 (Black)	
	Power	2 x 3-prong AC socket	
	PON	1 x RJ45 Female (Black)	
	Modem	1 x RJ45 Female (Black)	
	USB	3 x USB Type A Female (White)	
	USB Console (LUC)	1 x Mini USB	
	Local Console	1 x RJ45 Female (Black)	
Switches	Reset	1 x Recessed Pushbutton	
	Power	2 x Rocker Switch	
LEDs	Serial Port Status	8 (Green)	16 (Green)
	10 / 100 / 1000 Mbps	2 (Red / Orange / Green)	
	Power	2 (Blue)	
I/P Rating	AC	100-240V~, 1A, 50/60 Hz	
Power Consumption		110V/22.1W; 220V/21.8W	110V/22.9W; 220V/22.6W
Environment	Operating Temp.	0–50° C	
	Storage Temp.	-20–60° C	
	Humidity	0–80% RH Noncondensing	
Physical Properties	Housing	Metal	
	Weight	4.35 kg	4.38 kg
	Dimensions L x W x H	43.72 x 32.98 x 4.40 cm (19"1U)	43.72 x 32.98 x 4.40 cm (19"1U)

SN0132 / SN0148

Function		SN0132	SN0148
Serial Connections		32	48
Connectors	Serial	32 x RJ45 Female (Black)	48 x RJ45 Female (Black)
	LAN	2 x RJ-45	
	Power	2 x 3-prong AC socket	
	PON	1 x RJ45 Female (Black)	
	Modem	1 x RJ45 Female (Black)	
	USB	3 x USB Type A Female (White)	
	USB Console	1 x Mini USB	
	Local Console	1 x RJ45 Female (Black)	
Switches	Reset	1 x Recessed Pushbutton	
	Power	2 x Rocker Switch	
LEDs	Serial Port Status	32 (Green)	48 (Green)
	10 / 100 / 1000 Mbps	2 (Red / Orange / Green)	
	Power	2 (Blue)	
I/P Rating	AC	100–240V; 50/60Hz; 1.8A	
Power Consumption		120V/35W; 230V/37W	120V/42W; 230V/45W
Environment	Operating Temp.	0–50° C	
	Storage Temp.	-20–60° C	
	Humidity	0–80% RH Noncondensing	
Physical Properties	Housing	Metal	
	Weight	4.84 kg	4.92 kg
	Dimensions L x W x H	43.84 x 32.77 x 4.40 cm (19"1U)	43.84 x 32.77 x 4.40 cm (19"1U)

SN0132D / SN0148D

Function		SN0132D	SN0148D
Serial Connections		32	48
Connectors	RS-232 Serial Ports	32 x RJ45 Female (Black)	48 x RJ45 Female (Black)
	LAN	2 x RJ-45	
	Power	DC Terminal	
	PON	1 x RJ45 Female (Black)	
	Modem	1 x RJ45 Female (Black)	
	USB	3 x USB Type A Female (White)	
	USB Console	1 x Mini USB	
	Local Console	1 x RJ45 Female (Black)	
Switches	Reset	1 x Recessed Pushbutton	
	Power	2 x Rocker Switch	
LEDs	Serial Port Status	32 (Green)	48 (Green)
	10 / 100 / 1000 Mbps	2 (Red / Orange / Green)	
	Power	2 (Blue)	
I/P Rating	DC	36–48V DC; 1.6 A	
Power Consumption		48V;36W	48V;36W
Environment	Operating Temp.	0–50° C	
	Storage Temp.	-20–60° C	
	Humidity	0–80% RH Noncondensing	
Physical Properties	Housing	Metal	
	Weight	4.97 kg	5.05 kg
	Dimensions L x W x H	43.84 x 32.70 x 4.40 cm (19"1U)	

SN9108 / SN9116

Function		SN9108	SN9116
Serial Connections		8	16
Connectors	Serial	8 x RJ45 Female (Black)	16 x RJ45 Female (Black)
	LAN	1 x RJ-45	
	Power	1 x 3-prong AC socket	
Switches	Reset	1 x Recessed Pushbutton	
	Power	1 x Rocker Switch	
LEDs	Serial Port Status	8 (Green)	16 (Green)
	10 / 100 / 1000 Mbps	1 (Red / Orange / Green)	
	Power	1 (Blue)	
I/P Rating	AC	100-240V~, 1A, 50/60 Hz	
Power Consumption		110V/10.6W; 220V/11.7W	110V/11.5W; 220V/12.2W
Environment	Operating Temp.	0–50° C	
	Storage Temp.	-20–60° C	
	Humidity	0–80% RH Noncondensing	
Physical Properties	Housing	Metal	
	Weight	3.13 kg	3.16 kg
	Dimensions L x W x H	43.72 x 21.76 x 4.40 cm (19"1U)	43.72 x 21.76 x 4.40 cm (19"1U)

IP Address Determination

If you are an administrator logging in for the first time, you need to access the Serial Console Server in order to give it an IP address that users can connect to. There are three methods to choose from. In each case, your client computer must be on the same network segment as the Serial Console Server. After you have connected and logged in you can give the Serial Console Server its fixed network address. (See *Network*, page 93.)

The Local Console

The easiest way to assign an IP address is from the local console. Refer to *First Time Setup*, page 31, for details on the procedure involved.

IP Installer

For client computers running Windows, an IP address can be assigned with the *IP Installer* utility. The utility can be obtained from the *Download* area of our website. Look under *Driver/SW*, and the model of your Serial Console Server. After downloading the utility to your client computer, do the following:

1. Unzip the contents of *IPInstaller.zip* to a directory on your hard drive.
2. Go to the directory that you unzipped the IPInstaller program to and run *IPInstaller.exe*. A dialog box similar to the one below appears:

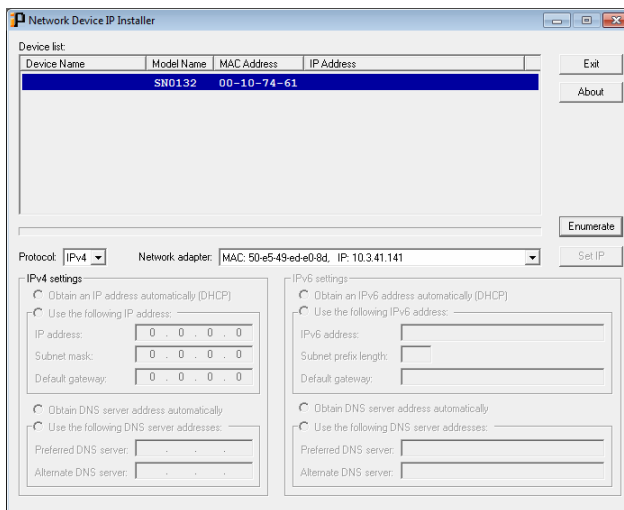

3. Select the Serial Console Server in the *Device List*.

Note: 1. If the list is empty, or your device doesn't appear, click **Enumerate** to refresh the Device List.

2. If there is more than one device in the list, use the MAC address to pick the one you want. The Serial Console Server MAC address is located on its bottom panel.

4. Select either *Obtain an IP address automatically (DHCP)*, or *Specify an IP address*. If you chose the latter, fill the IP Address, Subnet Mask, and Gateway fields with the information appropriate to your network.
5. Click **Set IP**.
6. After the IP address shows up in the Device List, click **Exit**. See *IP Installer*, page 94 for more information.

Browser

1. Set your client computer's IP address to 192.168.0.XXX
Where *XXX* represents any number or numbers except 60. (192.168.0.60 is the default address of the Serial Console Server.)
2. Specify the Serial Console Server's default IP address (192.168.0.60) in your browser, and you will be able to connect.
3. Assign a fixed IP address for the Serial Console Server that is suitable for the network segment that it resides on.
4. After you log out, reset your client computer's IP address to its original value.

IPv6

At present, the Serial Console Server supports three IPv6 address protocols: *Link Local IPv6 Address*, *IPv6 Stateless Autoconfiguration*, and *Stateful Autoconfiguration (DHCPv6)*.

Link Local IPv6 Address

At power on, the Serial Console Server is automatically configured with a Link Local IPv6 Address (for example, fe80:210:74ff:fe61:1ef). To find out what the Link Local IPv6 Address is, log in with the Serial Console Server IPv4 address and open the *Device Management* → *Device Information* page. The address is displayed in the *General* list box (see page 91).

Once you have determined what the IPv6 address is, you can use it when logging in from a browser or the Win and Java Client AP programs.

For example:

If you are logging in from a browser, you would key in

```
http://[fe80:2001:74ff:fe6e:59%5]
```

for the URL bar.

If you are logging in with the AP program, you would key:

```
fe80:2001:74ff:fe6e:59%5
```

for the *IP* field of the *Server* panel (see *Remote Login*, page 34).

-
- Note:**
1. To log in with the Link Local IPv6 Address, the client computer must be on the same local network segment as the Serial Console Server
 2. The %5 is the %interface used by the client computer. To see your client computer's IPv6 address: from the command line issue the following command: `ipconfig /all`. The % value appears at the end of the IPv6 address.
-

IPv6 Stateless Autoconfiguration

If the Serial Console Server network environment contains a device (such as a router) that supports the IPv6 Stateless Autoconfiguration function, the Serial Console Server can obtain its prefix information from that device in order to generate its IPv6 address. For example, 2001:74ff:fe6e:59.

As above, the address is displayed in the *General* list box of the *Device Management* → *Device Information* page (see page 91).

Once you have determined what the IPv6 address is, you can use it when logging in from a browser or the Win and Java Client AP programs.

For example:

If you are logging in from a browser, you would key in

```
http://[2001:74ff:fe6e:59]
```

for the URL bar.

If you are logging in with the AP program, you would key:

```
2001:74ff:fe6e:59
```

for the *IP* field of the *Server* panel.

Virtual Modem Details

The Serial Console Server's *Virtual Modem* function emulates a hardware modem to provide high speed serial modem functionality over an Ethernet LAN or WAN using TCP/IP rather than over slower, less-reliable, telephone lines.

AT Command Set Support

The Serial Console Server supports a subset of the standard Hayes command set, as well as some extended commands, as shown in the following table:

Command	Operation	Response
+++	Return to command mode. The escape character can be changed by modifying the S2 register.	none
A/	Repeat the last command string	If successful: OK[CR][LF] If failure: ERROR[CR][LF]
ATA[CR]	Answer mode. Allow virtual modem to listen for a TCP connection on the provided listen port: 5301.	If successful: OK[CR][LF] If failure: ERROR[CR][LF]
ATD(T) Remote IP:Remote Port[CR]	Try to establish a TCP connection and connect to the specified remote host. e.g. ATDT10.0.0.72:50001 Note: The SN3101 accepts T and P additions to the ATD command, but ignores them.	If successful: CONNECT[CR][LF] If connection failure: NO CARRIER[CR][CF] If other error: ERROR[CR][LF]
ATE n [CR]	Where n represents a numeric character (0 or 1.): E0: disable command echo E1: enable command echo	If successful: OK[CR][LF] If failure: ERROR[CR][LF]
ATH[CR]	Hang up current TCP connection if a connection is active. Note: ATH, ATH0, and ATH1 all act the same.	If successful: OK[CR][LF] If failure: ERROR[CR][LF]
ATI n [CR]	Inquiry command. (Where n represents a numeric character; 0 or 1.): E0: Display <i>ATEN International Co. Ltd.</i> E1: Display Serial Console Server	If successful: OK[CR][LF] If failure: ERROR[CR][LF]
ATOn[CR]	Return to on-line data mode. (Where n represents a numeric character; 0 or 1.) If the modem is in the on-line command mode, the modem enters on-line data mode. If the modem is in the off-line command mode (no TCP connection established), an ERROR is returned. O0, O1: If there is an active connection, switch the modem to data mode.	If an active TCP connection: OK[CR][LF] Otherwise: ERROR[CR][LF]
ATQ n [CR]	Result code control command. (Where n represents a numeric character; 0 or 1.) Q0: Enable result code to DTE (default) Q1: Disable result code to DTE.	If successful: OK[CR][LF] If failure: ERROR[CR][LF]
ATS n ?[CR]	Reports the value of the S register. (Where n is the register's number.)	If successful: OK[CR][LF] If failure: ERROR[CR][LF]
ATS n = v [CR]	Sets the S register's value. (Where n is the register's number; and v is the S register value.)	If successful: OK[CR][LF] If failure: ERROR[CR][LF]
ATV n [CR]	Result code return type. (Where n represents a numeric character; 0 or 1.) V0: Response is: <numeric code>[CR][LF] V1: Response is: <verbal description>[CR][LF]	If successful: OK[CR][LF] If failure: ERROR[CR][LF]

(Continued from previous page.)

Command	Operation	Response
ATZ[CR]	Reset modem command. Close active connections and reset the S registers and general option status to their saved values.	If successful: OK[CR][LF] If failure: ERROR[CR][LF]
AT&Cn[CR]	DCD option. (Where n represents a numeric character; 0 or 1.) &C0: DCD is ON at all times. &C1: DCD matches the state of the TCP connection.	If successful: OK[CR][LF] If failure: ERROR[CR][LF]
AT&Dn[CR]	DTR option. (Where n represents a numeric character; 0 – 3.) &D0: DTR is assumed to be ON. Modem ignores the DTR line. &D1: DTR OFF causes the modem to switch to command mode without disconnecting. &D2: DTR OFF switches modem to command mode; hangs up; and disables auto answer. (Default) &D3 DTR OFF initializes the modem.	If successful: OK[CR][LF] If failure: ERROR[CR][LF]
AT&F[CR]	Restore factory configuration. Reset S registers and general option status to default values.	If successful: OK[CR][LF] If failure: ERROR[CR][LF]
AT&W[CR]	Save configuration. Write the current configuration settings into memory, including the S register values and general option status.	If successful: OK[CR][LF] If failure: ERROR[CR][LF]
ATB[CR]	None	OK[CR][LF]
ATC[CR]	None	OK[CR][LF]
ATL[CR]	None	OK[CR][LF]
ATM[CR]	None	OK[CR][LF]
ATN[CR]	None	OK[CR][LF]
ATX[CR]	None	OK[CR][LF]
ATY[CR]	None	OK[CR][LF]
ATW[CR]	None	OK[CR][LF]
Other AT Commands	None	OK[CR][LF]

Port Forwarding

For devices located behind a router, port forwarding allows the router to pass data coming in over a specific port to a specific device. By setting the port forwarding parameters, you tell the router which device to send the data that comes in over a particular port to.

For example, if the Serial Console Server connected to a particular router has an IP address of 192.168.1.180, you would log into your router's setup program and access the Port Forwarding (sometimes referred to as *Virtual Server*) configuration page. You would then specify 192.168.1.180 for the IP address and the port number you want opened for it (9000 for internet access, for example).

Since configuration setup can vary somewhat for each brand of router, refer to the router's User Manual for specific information on configuring port forwarding for it.

Clear Login Information

If you are unable to perform an Administrator login (because the Username and Password information has become corrupted or you have forgotten it, for example) you can clear the login information with the following procedure.

Note: Performing this procedure also returns all settings to their defaults.

To clear the login information (and return all settings to their defaults), do the following:

1. Power off the Serial Console Server and remove its housing.
2. Use a jumper cap to short the mainboard jumper labeled **J15** (SN0132/0148) or **J17** (SN9108/9116/0108A/0116A).

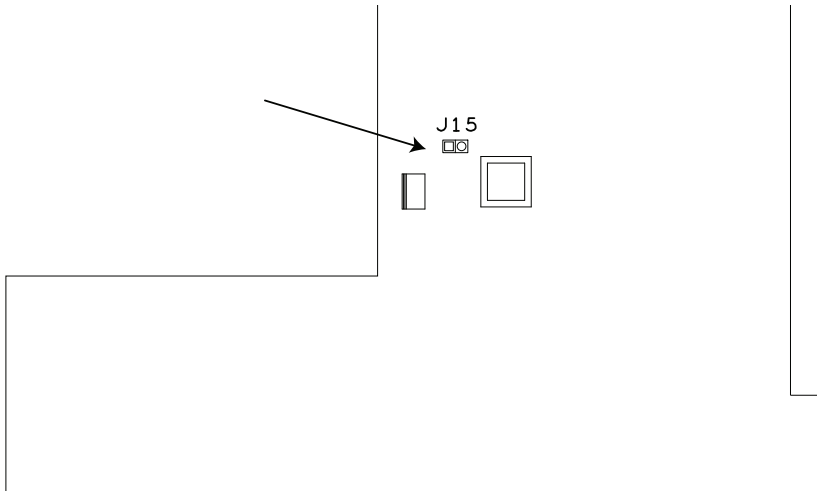

3. Power on the Serial Console Server.
4. When the LEDs flash, power off the Serial Console Server.
5. Remove the jumper cap from **J15** (SN0132/0148) or **J17** (SN9108/9116/0108A/0116A).
6. Close the housing and start the Serial Console Server.

After powering on the unit, you can use the default Super Administrator Username and Password (see *First Time Setup*, page 31), to log in.

RJ-45 to Serial Adapters

RJ-45 to Serial adapters are not included with the Serial Console Server package. To purchase these adapters, contact your dealer. The tables on the following pages describe the available adapter configurations.

SA0141: RJ45-F to DB9-F (Black Connector)

DTE to DTE

(RJ45)	Pins (8)		Computer (DB9)
RTS	1	←————→	8
DTR	2	←————→	6+1
TXD	3	←————→	2
CTS	4	←————→	7
GND	5	←————→	5
RXD	6	←————→	3
DSR	7&8	←————→	4
			9 NC not used

SA0142: RJ45-F to DB9-M (Black Connector)

DTE to DCE

(RJ45)	Pins (8)		Modem/Device (DB9)
RTS	1	←————→	7
DTR	2	←————→	4
TXD	3	←————→	3
CTS	4	←————→	8
GND	5	←————→	5
RXD	6	←————→	2
DCD	7	←————→	1
DSR	8	←————→	6
			9 NC not used

SA0143: RJ45-F to DB25-F (Black Connector)

DTE to DTE

(RJ45)	Pins (8)		Computer (DB25)
RTS	1	<—————>	5
DTR	2	<—————>	6+8
TXD	3	<—————>	3
CTS	4	<—————>	4
GND	5	<—————>	7
RXD	6	<—————>	2
DSR	7&8	<—————>	20
Other pins not used			

SA0144: RJ45-F to DB25-M (Black Connector)

DTE to DCE

(RJ45)	Pins (8)		Modem/Device (DB25)
RTS	1	<—————>	4
DTR	2	<—————>	20
TXD	3	<—————>	2
CTS	4	<—————>	5
GND	5	<—————>	7
RXD	6	<—————>	3
DCD	7	<—————>	8
DSR	8	<—————>	6
Other pins not used			

SA0145: RJ45-F to DB9-M (Blue Connector)

DTE to DTE

(RJ45)	Pins (8)		Computer (DB9)
RTS	1	←————→	8
DTR	2	←————→	6&1
TXD	3	←————→	2
CTS	4	←————→	7
GND	5	←————→	5
RXD	6	←————→	3
DSR	7&8	←————→	4
9 NC not used			

SA0146: RJ45-F to DB9-F (Blue Connector)

DTE to DCE

(RJ45)	Pins (8)		Modem/Device (DB9)
RTS	1	←————→	7
DTR	2	←————→	4
TXD	3	←————→	3
CTS	4	←————→	8
GND	5	←————→	5
RXD	6	←————→	2
DCD	7	←————→	1
DSR	8	←————→	6
9 NC not used			

SA0147: RJ45-F to DB25-M (Blue Connector)

DTE to DTE

(RJ45)	Pins (8)		Computer (DB25)
RTS	1	<—————>	5
DTR	2	<—————>	6+8
TXD	3	<—————>	3
CTS	4	<—————>	4
GND	5	<—————>	7
RXD	6	<—————>	2
DSR	7&8	<—————>	20
Other pins not used			

SA0148: RJ45-F to DB25-F (Blue Connector)

DTE to DCE

(RJ45)	Pins (8)		Modem/Device (DB25)
RTS	1	<—————>	4
DTR	2	<—————>	20
TXD	3	<—————>	2
CTS	4	<—————>	5
GND	5	<—————>	7
RXD	6	<—————>	3
DCD	7	<—————>	8
DSR	8	<—————>	6
Other pins not used			

Limited Warranty

ALTUSEN warrants this product against defects in material or workmanship for a period of one (1) year from the date of purchase. If this product proves to be defective, contact ALTUSEN's support department for repair or replacement of your unit. ALTUSEN will not issue a refund. Return requests can not be processed without the original proof of purchase.

When returning the product, you must ship the product in its original packaging or packaging that gives an equal degree of protection. Include your proof of purchase in the packaging and the RMA number clearly marked on the outside of the package.

This warranty becomes invalid if the factory-supplied serial number has been removed or altered on the product.

This warranty does not cover cosmetic damage or damage due to acts of God, accident, misuse, abuse, negligence or modification of any part of the product. This warranty does not cover damage due to improper operation or maintenance, connection to improper equipment, or attempted repair by anyone other than ALTUSEN. This warranty does not cover products sold AS IS or WITH FAULTS.

IN NO EVENT SHALL ALTUSEN'S LIABILITY EXCEED THE PRICE PAID FOR THE PRODUCT. FURTHER, ALTUSEN SHALL NOT BE RESPONSIBLE FOR DIRECT, INDIRECT, SPECIAL, INCIDENTAL OR CONSEQUENTIAL DAMAGES RESULTING FROM THE USE OF THE PRODUCT, ITS ACCOMPANYING SOFTWARE, OR ITS DOCUMENTATION. ALTUSEN SHALL NOT IN ANY WAY BE RESPONSIBLE FOR, WITHOUT LIMITATION, LOSS OF DATA, LOSS OF PROFITS, DOWNTIME, GOODWILL, DAMAGE OR REPLACEMENT OF EQUIPMENT OR PROPERTY, AND ANY EXPENSES FROM RECOVERY, PROGRAMMING, AND REPRODUCTION OF ANY PROGRAM OR DATA.

ALTUSEN makes no warranty or representation, expressed, implied, or statutory with respect to its products, contents or use of this documentation and all accompanying software, and specifically disclaims its quality, performance, merchantability, or fitness for any particular purpose.

ALTUSEN reserves the right to revise or update its product, software or documentation without obligation to notify any individual or entity of such revisions, or update.

For details about extended warranties, please contact one of our dedicated value added resellers.