

USB KVM Extender

USER MANUAL

CE700A

FCC INFORMATION

This is an FCC Class A product. In a domestic environment this product may cause radio interference in which case the user may be required to take adequate measures.

This equipment has been tested and found to comply with the limits for a Class A digital device, pursuant to Part 15 of the FCC Rules. These limits are designed to provide reasonable protection against harmful interference when the equipment is operated in a commercial environment. This equipment generates, uses and can radiate radio frequency energy and, if not installed and used in accordance with the instruction manual, may cause harmful interference to radio communications. Operation of this equipment in a residential area is likely to cause harmful interference in which case the user will be required to correct the interference at his own expense.

USER NOTICE

This ATEN product is specifically designed and manufactured for the operation and management of computer mainframe and communications equipment used in network management centers. As such, it may not be completely appropriate for those environments and sites where special standards for performance and high reliability are required – such as military equipment, traffic management, nuclear facilities, security systems, communications equipment, medical facilities, etc.

ROHS

This product is RoHS compliant.

SJ/T 11364-2006

The following contains information that relates to China.

部件名称	有毒有害物质或元素					
	铅	汞	镉	六价铬	多溴联苯	多溴二苯醚
电器部件	●	○	○	○	○	○
机构部件	○	○	○	○	○	○

○：表示该有毒有害物质在该部件所有均质材料中的含量均在SJ/T 11363-2006规定的限量要求之下。

●：表示符合欧盟的豁免条款，但该有毒有害物质至少在该部件的某一均质材料中的含量超出SJ/T 11363-2006的限量要求。

×：表示该有毒有害物质至少在该部件的某一均质材料中的含量超出SJ/T 11363-2006的限量要求。



CE700A USER MANUAL

ONLINE REGISTRATION

International	http://support.aten.com
North America	http://www.aten-usa.com/product_registration

TELEPHONE SUPPORT

International		886-2-8692-6959
China		86-10-5160-1602
Japan		81-3-5323-7178
Korea		82-2-467-6789
North America	ATEN TECH	1-888-999-ATEN
	ATEN NJ	1-732-356-1703
United Kingdom		44-8-4481-58923

TECHNICAL SUPPORT

- ◆ For international online technical support – including troubleshooting, documentation, and software updates:
<http://support.aten.com>
- ◆ For North American technical support:

Email		ATEN TECH	support@aten-usa.com
		ATEN NJ	sales@aten.com
Online	Technical Support	ATEN TECH	http://www.aten-usa.com/support
		ATEN NJ	http://support.aten.com
	Troubleshooting Documentation Software Updates	ATEN TECH	http://www.aten-usa.com
		ATEN NJ	http://www.aten.com
Telephone		ATEN TECH	1-888-999-ATEN
		ATEN NJ	1-732-356-1703

PACKAGE CONTENTS

The CE700A USB KVM Extender package contains the following:

- ◆ 1 CE700AL USB KVM Extender (Local Unit)
- ◆ 1 CE700AR USB KVM Extender (Remote Unit)
- ◆ 1 USB KVM Cable (1.8 m)
- ◆ 2 Power Adapters
- ◆ 2 Rack Mount Kits
- ◆ 2 Grounding Wires
- ◆ 1 User Manual*
- ◆ 1 Quick Start Guide

Check to make sure that all the components are present and that nothing got damaged in shipping. If you encounter a problem, contact your dealer.

Read this manual thoroughly and follow the installation and operation procedures carefully to prevent any damage to the unit, and/or any of the devices connected to it.

* Features may have been added to the CE700A since this manual was printed. Please visit our website to download the most up-to-date version of the manual.

Copyright © 2009 ATEN® International Co., Ltd.
Manual Part No. PAPE-1341-AT1G
Manual Date: 2009-10-14

ATEN and the ATEN logo are trademarks of ATEN International Co., Ltd. All rights reserved. All other trademarks are the property of their respective owners.

OVERVIEW

The CE700A is a USB KVM Extender with superior video quality and built-in ESD and surge protection that allows access to a computer system from a remote USB console (USB keyboard, monitor, and USB mouse).

Because it allows access to a computer system from a remote console, the CE700A is perfect for use in any type of installation where you need to place the console where it is conveniently accessible, but you want the system equipment to reside in a safe location – away from the dust and dirt of the factory floor, or the harsh environmental influence of a construction site, for example.

The CE700A is also useful for control and security purposes, where you can have the system unit in a secure area at the same time that you put the console in the most convenient location for user access.

The CE700A improves on previous designs by: 1) incorporating 15KV ESD protection and 2KV surge protection; 2) providing superior video quality – up to 1920 x 1200 resolution; 3) using inexpensive Cat 5 cable, instead of bulkier, more expensive, standard cables, for a much neater, more convenient, more reliable data transfer connection; 4) it is able to sense the distance to the system and automatically adjusts the gain accordingly; and 5) it features a custom ASIC to ensure the utmost in reliability and compatibility.

Setup is as easy as can be – simply connect the computer system box and local console to the Local CE700A Module; run the Cat 5 cable to the Remote CE700A Module (up to 150 meters away); and plug the remote console into the Remote Module.

Note: You can control numerous remote systems from a single console by combining the CE700A with a KVM switch.

FEATURES

- ◆ Local and Remote Units connect at distances up to 150 m using Cat 5e cable
- ◆ Dual console operation – control your system from both the local and remote USB keyboard, monitor, and mouse consoles
- ◆ Built-in ASIC for greater reliability and compatibility
- ◆ Auto Signal Compensation (ASC)
- ◆ USB Keyboard and USB Mouse Ports
- ◆ USB overcurrent detection and prevention
- ◆ Pushbutton operating mode selection (Local Unit only) – select between Local and Auto operating modes.
- ◆ Built-in 8KV/15KV ESD protection (Contact voltage 8KV; Air voltage 15KV) and 2KV surge protection
- ◆ Automatic gain control – adjusts signal strength to compensate for distance
- ◆ High resolution video – up to 1920 x 1200@60Hz (30 m); 1600 x 1200@60Hz (100 m); 1280 x 1024@60Hz (150 m)
- ◆ Supports VGA, SVGA, SXGA, UXGA, WUXGA, and multisync monitors; local monitor supports DDC; DDC2; DDC2B
- ◆ Hot pluggable
- ◆ Rack mountable
- ◆ Easy to install – no software required – connecting cables to the devices is all it takes

SYSTEM REQUIREMENTS

CONSOLES

- ◆ A VGA, SVGA, SXGA, UXGA, WUXGA, or Multisync monitor capable of the highest resolution that you will be using on the installation
- ◆ A USB keyboard
- ◆ A USB mouse

COMPUTERS

The following equipment must be installed on each computer that is to be connected to the system:

- ◆ A VGA, SVGA, SXGA, UXGA, WUXGA, or Multisync card
- ◆ USB Host Controller and Type A USB Port

CABLES

- ◆ For optimal signal integrity, and to simplify the layout, we strongly recommend that you use the high quality custom USB KVM Cable that is provided with this package.
- ◆ Cat 5e cable is the minimum required to connect the local and remote CE700A units. Cable of a lesser standard will result in degrading the video signal. For best performance, we strongly recommend Cat 5e cable.

SUPPORTED OPERATING SYSTEMS

OS		Version
Windows		2000, XP, Vista
Linux	RedHat	7.1 and higher
	SuSE	9.0 and higher
	Mandriva (Mandrake)	9.0 and higher
UNIX	FreeBSD	4.2 and higher
Novell	Netware	6.0 and higher

COMPONENTS

CE700AL (LOCAL UNIT) FRONT VIEW

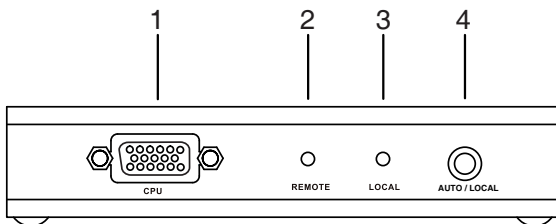

CE700AR (REMOTE UNIT) FRONT VIEW

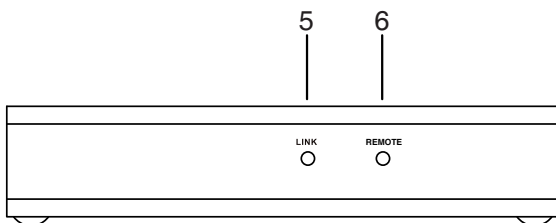

No.	Component	Description
1	KVM Port	The custom USB KVM cable that links the unit to the computer plugs in here.
2	Remote LED	The CE700AL has two LEDs to indicate operating status. See <i>LED Display</i> , page 17, for details.
3	Local LED	
4	Operating Mode Selection Pushbutton	This pushbutton toggles the operating mode between Auto and Local. See <i>Operating Modes</i> , page 16, for details.
5	Link LED	The CE700AR has two LEDs to indicate operating status. See <i>LED Display</i> , page 17, for details.
6	Remote LED	

CE700AL / CE700AR REAR VIEW

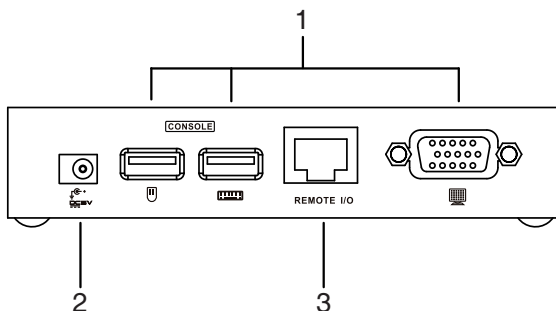

CE700AL / CE700AR SIDE VIEW

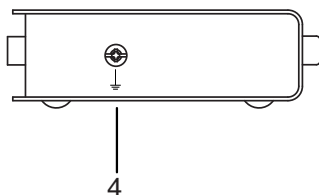

No.	Component	Description
1	Console Ports	The local and remote console's USB keyboard, USB mouse, and monitor plug into these ports.
2	Power Jack	The power adapter cable plugs into this jack.
3	Remote I/O	The Cat 5e cable that connects the local and remote units plugs in here.
4	Grounding Terminal	The grounding wire attached here. See <i>Installation</i> , page 11, for details.

HARDWARE SETUP



Make sure that the power to any device that you connect to the installation has been turned off. You must unplug the power cords of any computers that have the *Keyboard Power On* function.

RACK MOUNTING

For convenience and flexibility, the CE700AL and CE700AR can be mounted on system racks.

1. Using the screws provided in the Rack Mount Kit, screw the mounting bracket into the top or bottom of the unit as shown:

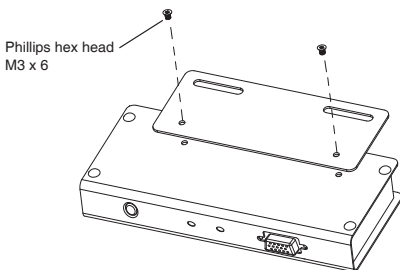

2. Screw the bracket into any convenient location on the rack.

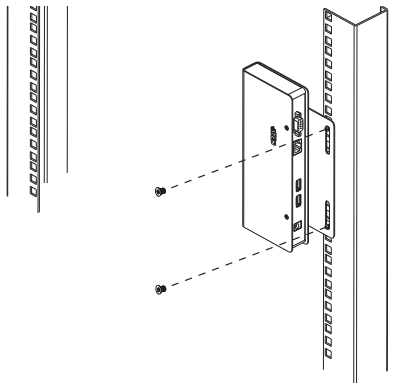

INSTALLATION

GROUNDING

To prevent damage to your installation it is important that all devices are properly grounded.

1. Use the two grounding wires supplied with this package to ground both units by connecting one end of the wire to the grounding terminal, and the other end of the wire to a suitable grounded object.

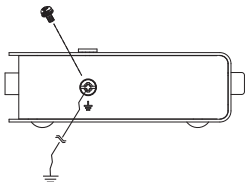

2. Make sure that the computer that the CE700AL connects to and the monitor that the CE700AR connects to are properly grounded.

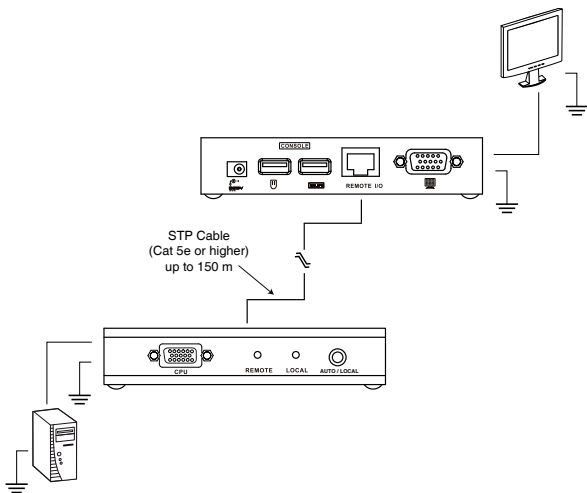

3. For increased grounding protection, use STP (shielded twisted pair) cable to connect the Local and Remote Units. There are two methods that can be used:

- a) In addition to the eight paired wires, STP cable also contains a grounding wire. Solder this wire to the RJ-45 connector as shown in the diagram below:

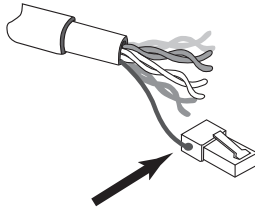

- b) The second method is to use the STP cable shielding for grounding. In this case, make sure that the shielding makes tight contact with the top inside of the RJ-45 connector as shown in the diagram below:

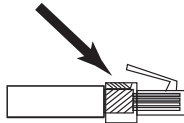

In either case, make sure that the sides of the RJ-45 connector make tight contact with the grounding contacts on the sides of the RJ-45 socket as shown in the diagram below:

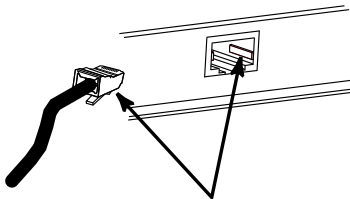

Setting up the USB KVM Extender system is simply a matter of plugging in the cables. Refer to the installation diagram on the following page and do the following:

CONNECTING THE CABLES

1. Plug the cables from the local console devices (mouse, keyboard, monitor, microphone, speakers) into their ports on the Console section on the rear of the Local Unit (CE700AL).
2. Plug the appropriate connectors on the USB KVM cable supplied with this unit into their ports on the KVM section on the front of the Local Unit (CE700AL).
3. Plug the connectors on the other end of the USB KVM cable into the appropriate ports on the local computer.

Note: If you are combining the CE700A with a KVM switch, the other end of the USB KVM cable plugs into the appropriate ports on the KVM switch.

4. Plug one end of the Cat 5e cable into the CE700AL's Remote I/O port. Plug the other end of the Cat 5e cable into the I/O port of the Remote Unit (CE700AR).
5. Plug one of the power adapters (supplied with this package) into an AC source; plug the adapter's power cable into the CE700AL's Power Jack
6. Plug the cables from the remote console devices into their ports on the Console side of the CE700AR.
7. Plug the second power adapter (supplied with this package) into an AC source; plug the adapter's power cable into the CE700AR's Power Jack.

CE700AL / CE700AR REAR VIEW

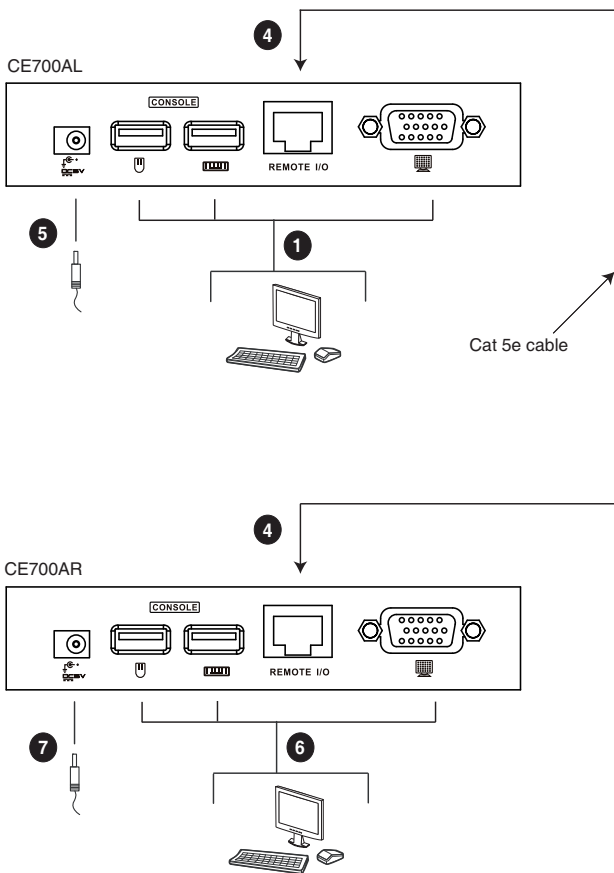

CE700AL FRONT VIEW

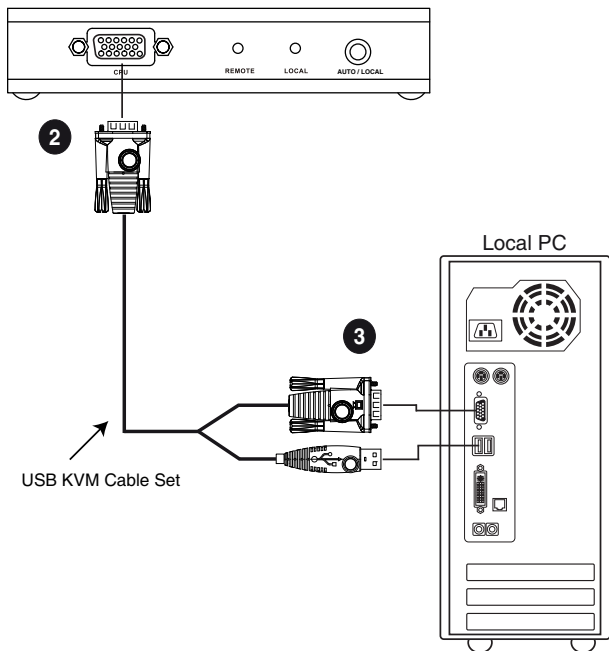

OPERATING MODES

The CE700A USB KVM Extender system has three operating modes: Local, Auto, and Remote, as shown in the table, below:

Mode	Description
Local	Only the local console has KVM access. The remote console's keyboard and mouse input is disabled.
Auto	Both the local and remote consoles can have KVM access, but not at the same time. The console without access has to wait until the active console stops inputting data before it can gain access.
Remote	The remote console has KVM access. Remote cannot be selected; it can only occur when the pushbutton on the CE700AL is set to <i>Auto</i> and the local console is idle. If the remote console is then idle for more than five seconds, the local console can gain access.

Note: The default operating mode is *Auto*.

LED DISPLAY

The Local and Remote Units each have two LEDs to indicate their operating status, as shown in the tables, below:

CE700AL (LOCAL UNIT)

LED	Indication
Local (Green)	<ul style="list-style-type: none">◆ Lights to indicate that the local console is active (Remote LED is off)◆ Off when remote console is active◆ Flashes to indicate Auto mode (neither console is active)
Remote (Green)	<ul style="list-style-type: none">◆ Lights to indicate that the remote console is active (Local LED is off)◆ Off when local console is active◆ Flashes to indicate Auto mode (neither console is active)

CE700AR (REMOTE UNIT)

LED	Indication
Link (Green)	<ul style="list-style-type: none">◆ Lights steadily to indicate that the connection to the local unit is working.◆ Flashes to indicate a problem with the connection to the local unit (remote LED is off)
Remote (Green)	<ul style="list-style-type: none">◆ Lights to indicate that the remote console is active (Local LED is off)◆ Off when local console is active◆ Flashes to indicate Auto mode (neither console is active)

SPECIFICATIONS

Function		CE700AL	CE700AR	
Connectors	Console Ports	Keyboard	1 x USB Type A Female (White)	
		Video	1 x HDB-15 Female (Blue)	
		Mouse	1 x USB Type A Female (White)	
	KVM Ports	KB / Video / Mouse	1 x SPHD-17 Female (Green)	N/A
	Unit to Unit		1 x RJ-45 Female (Black)	
	Power		1 x DC Jack (Black)	
Pushbuttons	Operating Mode Selection	1 x Pushbutton	N/A	
LEDs	Local	1 (Green)	N/A	
	Remote	1 (Green)	1 (Green)	
	Link	N/A	1 (Green)	
Emulation	Keyboard / Mouse	USB		
Power Consumption		DC 5.3V, 2.31W	DC 5.3V, 2.84W	
Video Resolution		Up to 1920 x 1200 @ 60 Hz		
Environment	Operating Temp.	0–50°C		
	Storage Temp	-20–60°C		
	Humidity	0–80% RH, Non-condensing		
Physical Properties	Housing	Metal		
	Weight	0.32 kg	0.31 kg	
	Dimensions (L x W x H)	12.50 x 8.15 x 2.5 cm		

TP WIRING DIAGRAMS

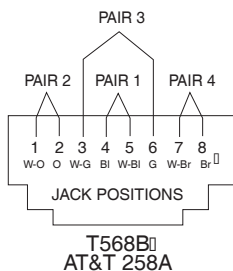
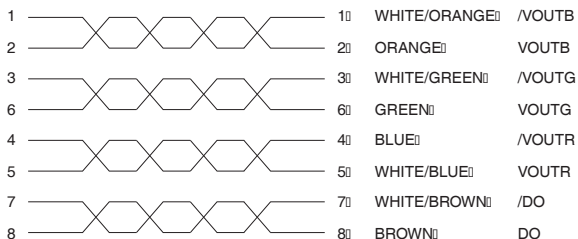

TP PIN ASSIGNMENTS

Pin	Assignment
1	V OUT B
2	/V OUT B
3	V OUT G
4	V OUT R
5	/V OUT R
6	/V OUT G
7	/DO
8	DO

TROUBLESHOOTING

Problem	Action
No video	Make sure that all cables are securely plugged into their sockets.
Poor video quality.	The video quality can be improved by reducing the refresh rate.

ABOUT SPHD CONNECTORS



This product uses SPHD connectors for its KVM and/or Console ports. We have specifically modified the shape of these connectors so that only KVM cables that we have designed to work with this product can be connected.



LIMITED WARRANTY

IN NO EVENT SHALL THE DIRECT VENDOR'S LIABILITY EXCEED THE PRICE PAID FOR THE PRODUCT FROM THE DIRECT, INDIRECT, SPECIAL, INCIDENTAL OR CONSEQUENTIAL DAMAGES RESULTING FROM THE USE OF THE PRODUCT, DISK OR ITS DOCUMENTATION.

The direct vendor makes no warranty or representation, expressed, implied, or statutory with respect to the contents or use of this documentation, and specially disclaims its quality, performance, merchantability, or fitness for any particular purpose.

The direct vendor also reserves the right to revise or update the device or documentation without obligation to notify any individual or entity of such revisions, or update. For further inquires please contact your direct vendor.