



# 4K HDMI Matrix Switch

---

USER MANUAL

**VM0202H**

## EMC INFORMATION

### FEDERAL COMMUNICATIONS COMMISSION INTERFERENCE

**STATEMENT:** This equipment has been tested and found to comply with the limits for a Class A digital device, pursuant to Part 15 of the FCC Rules. These limits are designed to provide reasonable protection against harmful interference when the equipment is operated in a commercial environment. This equipment generates, uses, and can radiate radio frequency energy and, if not installed and used in accordance with the instruction manual, may cause harmful interference to radio communications. Operation of this equipment in a residential area is likely to cause harmful interference in which case the user will be required to correct the interference at his own expense.

This device complies with Part 15 of the FCC Rules. Operation is subject to the following two conditions: (1) this device must not cause harmful interference, and (2) this device must accept any interference received, including interference that may cause undesired operation.

**FCC Caution:** Any changes or modifications not expressly approved by the party responsible for compliance could void the user's authority to operate this equipment.

**Warning:** Operation of this equipment in a residential environment could cause radio interference.

**Warning:** This equipment is compliant with Class A of CISPR 32. In a residential environment this equipment may cause radio interference.

### KCC Statement

유선 제품용 / A 급 기기 ( 업무용 방송 통신 기기 )

이 기기는 업무용 (A 급) 전자파적합기기로서 판매자 또는 사용자는 이점을 주의하시기 바라며, 가정 외의 지역에서 사용하는 것을 목적으로 합니다.

### RoHS

This product is RoHS compliant.

### SJ/T 11364-2006

The following contains information that relates to China.

部件名称	有毒有害物质或元素					
	铅	汞	镉	六价铬	多溴联苯	多溴二苯醚
电器部件	●	○	○	○	○	○
机构部件	○	○	○	○	○	○

○: 表示该有毒有害物质在该部件所有均质材料中的含量均在SJ/T 11363-2006规定的限量要求之下。

●: 表示符合欧盟的豁免条款, 但该有毒有害物质至少在该部件的某一均质材料中的含量超出SJ/T 11363-2006的限量要求。

×: 表示该有毒有害物质至少在该部件的某一均质材料中的含量超出SJ/T 11363-2006的限量要求。



# VM0202H USER MANUAL

## ONLINE REGISTRATION

International	<a href="http://eservice.aten.com">http://eservice.aten.com</a>
---------------	---

## TELEPHONE SUPPORT

International	886-2-8692-6959
China	86-400-810-0-810
Japan	81-3-5615-5811
Korea	82-2-467-6789
North America	1-888-999-ATEN ext 4988
United Kingdom	44-8448-158923

## TECHNICAL SUPPORT

- ◆ For international online technical support – including troubleshooting, documentation, and software updates:  
**<http://eservice.aten.com>**
- ◆ For North American technical support:

Email Support		<a href="mailto:support@aten-usa.com">support@aten-usa.com</a>
Online Technical Support	Troubleshooting Documentation Software Updates	<a href="http://www.aten-usa.com/support">http://www.aten-usa.com/support</a>
Telephone Support		1-888-999-ATEN ext 4998

## PACKAGE CONTENTS

The VM0202H 2x2 4K HDMI Matrix Switch package contains the following items:

- ◆ 1 VM0202H 2x2 4K HDMI Matrix Switch
- ◆ 1 Rack Mounting Kit
- ◆ 1 User Instructions\*
- ◆ 1 Power Adapter
- ◆ 1 IR Control
- ◆ 1 IR Receiver

Check to make sure that all the components are present and that nothing got damaged in shipping. If you encounter a problem, contact your dealer.

Read this manual thoroughly and follow the installation and operation procedures carefully to prevent any damage to the unit, and/or any of the devices connected to it.

---

\* Features may have been added to the VM0202H since this manual was printed. Please visit our website to download the most up-to-date version of the manual.

---

Copyright © 2017 ATEN® International Co., Ltd.  
Manual Date: 2017-03-14

ATEN and the ATEN logo are trademarks of ATEN International Co., Ltd. All rights reserved. All other trademarks are the property of their respective owners.

## OVERVIEW

The ATEN VM0202H, a 2x2 4K HDMI Matrix Switch supports up to 4K resolutions, including UHD (3840 x 2160) and DCI (4096 x 2160), and refresh rates of 30 Hz (4:4:4) and 60 Hz (4:2:0). Ready for future high-definition trends, the VM0202H is ideal for applications where the routing of up to 4K digital video signals is required, such as in classrooms, auditoriums and department stores.

The matrix switch offers an easy and affordable way to route any of 2 HDMI video sources to any of 2 HDMI displays and can be controlled and operated through front-panel pushbuttons, IR and RS-232, ensuring optimum control capabilities.

## FEATURES

- ◆ Connects any of 2 HDMI sources to any of 2 HDMI displays
- ◆ Supports 4K resolutions of UHD (3840 x 2160) and DCI (4096 x 2160) with refresh rates of 30 Hz (4:4:4) and 60 Hz (4:2:0)
- ◆ EDID Expert™ – selects optimum EDID settings for smooth power-up, high-quality display, and use of the best video resolution across different screens
- ◆ Multiple Control Methods – system management via front-panel pushbuttons, IR and RS-232 serial control
- ◆ Supports Dolby True HD and DTS HD Master audio
- ◆ Signaling rates up to 3.4 Gbits for flawless 4K output
- ◆ HDMI (3D, Deep Color, 4K) and HDCP 1.4 compatible
- ◆ Consumer Electronics Control (CEC) allows interconnected HDMI devices to communicate and respond to a single remote control
- ◆ Supports ATEN LockPro™ HDMI cable lock for securing HDMI cables
- ◆ ESD protection for HDMI ports
- ◆ Firmware upgradeable
- ◆ Rack Mountable 1U design

# SYSTEM REQUIREMENTS

## SOURCE DEVICES

- ◆ HDMI Type A output connector(s)

---

**Note:** A DVI/HDMI adapter is required when connecting a DVI source device.

---

## DISPLAY DEVICES

- ◆ Display devices or receivers with an HDMI Type A input connector

## CABLES

- ◆ 1 HDMI cable for each source device you will be connecting
- ◆ 1 HDMI cable for each display device you will be connecting

---

**Note:** 1. No cables are included in this package. We strongly recommend that you purchase high-quality cables of the appropriate length since this will affect the quality of the audio and video display. Contact your dealer to purchase the correct cable sets.

2. If you wish to utilize the VM0202H's high-end serial controller function, you will need to purchase an appropriate RS-232 cable. See *Installing the RS-232 Controller*, page 12.

---

# COMPONENTS

## VM0202H FRONT VIEW

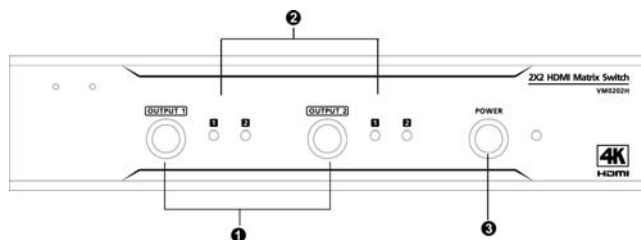

No.	Component	Function
1	Output Pushbuttons	Press an Output Port Pushbutton to select an Input Port.  Note: The OUTPUT (1-2) front panel pushbuttons have built-in Green LEDs that light to indicate they have been selected.
2	Input Select LEDs	Indicates the input port of the corresponding output port (output 1 or 2)
3	Power Pushbutton	This Pushbutton is to power on and off the VM0202H.



## VM0202H REAR VIEW

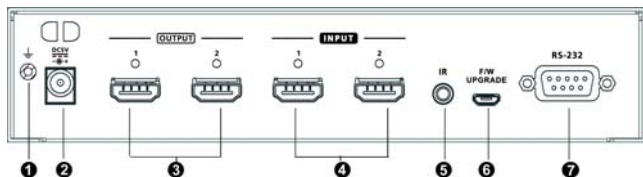

No.	Component	Function
1	Grounding Terminal	The grounding wire attaches here. See <i>Grounding</i> , page 11, for further details.
2	Power Jack	This is the DC power jack. The power cord from a power source plugs in here.
3	HDMI Output Ports	The cables from the HDMI display devices plug into these ports.
4	HDMI Input Ports	The cables from the HDMI source devices plug into these ports.
5	External IR Receiver Port	This 3.5 mm Mini Stereo Jack connects to the IR Receiver unit included with your product.
6	Micro USB Port	Use this port to upgrade the Firmware. see <i>Firmware Upgrade</i> , page 17
7	RS-232 Serial Port	This serial remote port is for input source selection.

## IR REMOTE CONTROL

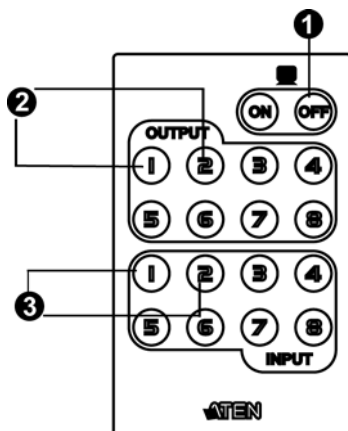

No.	Component	Function
1	Power ON/OFF	Use the <b>ON</b> and <b>OFF</b> pushbuttons to turn the Output displays on or off – by individual port, or all ports. See <i>IR Remote Selection</i> , page 16 for details.
2	Output Pushbuttons 1–2	Press <b>Output</b> pushbuttons 1–2 to select the display you want to configure, then within 2 seconds press the <b>Input</b> pushbutton 1–2 to select the source for the display. For detailed instructions, see <i>Output Pushbuttons</i> , page 15.
3	Input Pushbuttons 1–2	Press <b>Input</b> pushbuttons 1–2 to select the source you want to display after you have pressed an Output pushbutton 1–2. You must press the Input pushbutton within 2 seconds after pressing the Output pushbutton. For detailed instructions, see , page 15.

**Note:** The model number of the remote control unit shown above is 2XRT-0106G.

## INSTALLATION



1. Make sure that the power to any device that you connect to the installation has been turned off.
2. Make sure that all devices you will be installing are properly grounded.

Installation of the VM0202H is simply a matter of plugging in the appropriate cables. To install the switch, refer to the installation diagram below as you perform the following steps:

1. (Optional) If you are using the serial control function, use an appropriate RS-232 serial cable to connect the computer or serial controller to the VM0202H's female **RS-232** port.
2. Use a grounding wire to ground the unit by connecting one end of the wire to the grounding terminal and the other end of the wire to a suitably grounded object.

---

**Note:** Note: Do not omit this step. Proper grounding helps to prevent damage to the unit from surges and static electricity.

---

3. Use HDMI cables to connect the video display devices to the **HDMI output ports** on the rear of the VM0202H.
4. Use HDMI cables to connect the video source devices to the **HDMI input ports**.
5. Connect the IR Receiver to the **External IR Receiver** Input Port.
6. Plug the provided power adapter into an appropriate AC power source; plug the power adapter cable into the Power Jack on the VM0202H.
7. You may now power on the display and source devices.

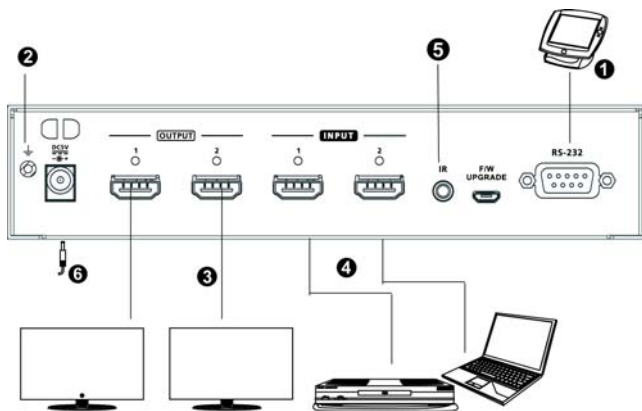

## INSTALLING THE RS-232 CONTROLLER

In order to use the RS-232 serial interface to attach a high-end controller (such as a PC) to the VM0202H, use an appropriate serial cable (such as a modem cable). The end connecting to the VM0202H should have a 9-pin male connector. Connect this to the serial interface on the rear of the VM0202H. Refer to number 1 on the diagram above.

---

**Note:** To configure the controller serial port, see page 19.

---

## RACK MOUNTING



1. Important safety information regarding the placement of this device is provided on page 26. Please review it before proceeding.
2. Make sure that the power to all devices connected to the installation are turned off. You must unplug the power cords of any computers that have the Keyboard Power On function.

The VM0202H can be mounted on the side of the system rack. For the most convenient front panel pushbutton configuration and operation at the local site, mount the unit at the front of the rack, as follows:

1. Use the M3 x 6 Phillips head hex screws supplied with the Rack Mount Kit to screw the rack mounting brackets onto the side of the unit.

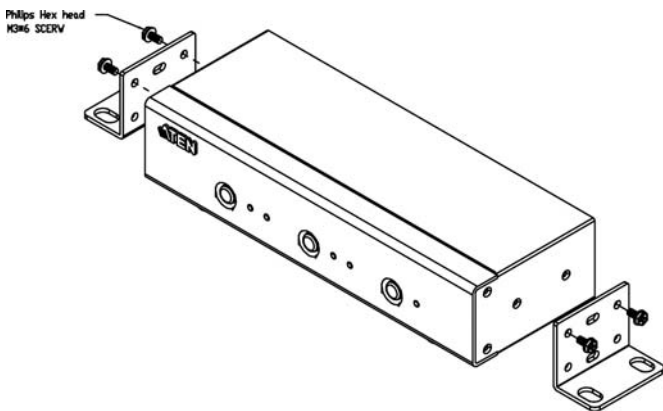

2. Position the unit in the front of the rack and align the holes in the mounting brackets with the holes in the rack.

*(continues on next page)*

3. Screw the mounting brackets to the rack.

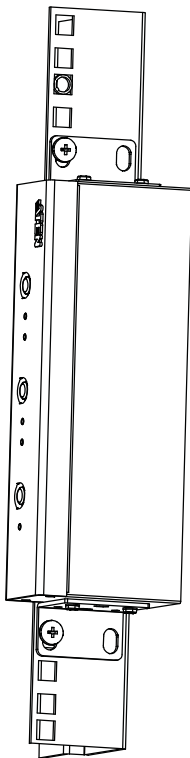

## **SOURCE DEVICE SELECTION**

The VM0202H offers easy and flexible source and display selection via front panel pushbuttons, IR remote control, and the RS-232 serial interface.

## **FRONT PANEL SELECTION**

To manually select an HDMI source for an HDMI display use the front panel pushbuttons to select the Output and Input connections.

Press the Output pushbutton that corresponds to the port, which the display is connected to. Pressing the pushbutton will cycle between the two attached HDMI source devices through the display devices. Advanced selection methods are explained below.

## **OUTPUT PUSHBUTTONS**

Pressing an output port selection pushbutton will cycle through the two HDMI input sources (source **1** and **2**)

## IR REMOTE SELECTION

The remote control can change the Input source for any Output display, power on/off individual Output displays and power on/off all Output displays simultaneously. Before using the remote control, the IR External Receiver must first be plugged into the rear of the VM0202H and placed where the IR signals can be received.

### TO CHANGE A DISPLAY'S SOURCE DEVICE:

1. Press the **Output** port number (1-2) you want to change.
2. Press the **Input** port number (1-2) to select the new input source for the display.

### TO POWER ON/OFF ALL DISPLAYS:

1. Press the **ON** or **OFF** pushbutton.

The ON or OFF pushbutton. The ON and OFF pushbuttons will set all output devices to ON or OFF.

### TO POWER ON/OFF INDIVIDUAL DISPLAYS:

1. Press the **Output** port number (1-2) you want to power on/off.
2. Press the **ON** or **OFF** pushbutton.



## FIRMWARE UPGRADE

To upgrade the firmware, power off the VM0202H and do the following:

1. Download the firmware upgrade package from the VM0202H product page on our website: [www.aten.com](http://www.aten.com)
2. Save and unzip the VM0202H\_upgrade\_tool.exe (upgrade file) to your computer.
3. Connect the computer to the VM0202H's Micro USB port via a USB cable.
4. Power on the VM0202H.
5. After a few seconds, double click the VM0202H\_upgrade\_tool.exe file to start the firmware upgrade process, and a window appears:

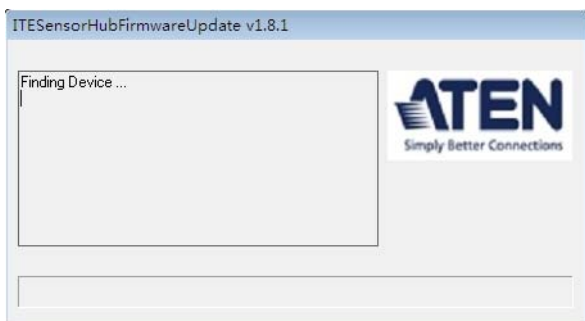

6. After the upgrade is complete, a message will appear:

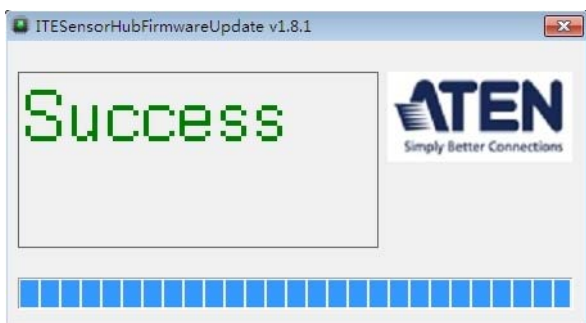

7. Power off VM0202H, then power it back on again.

## RS-232 SERIAL INTERFACE

The VM0202H's built-in bi-directional RS-232 serial interface allows system control through a high-end controller, PC, and/or home automation / home theater software package.

### CONFIGURING THE SERIAL PORT

The controller's serial port should be configured as follows:

Baud Rate	19200
Data Bits	8
Parity	None
Stop Bits	1
Flow Control	None

### SWITCH PORT COMMANDS

The formula for Switch Port commands are as follows:

**Switch Command + Input Command + Port number + Output Command + Port Number + Control + [Enter]**

1. For example, to switch input port 02 (audio and video) to output port 01, type the following:

**sw i02 o01 [Enter]**

2. To turn off video and audio on port 02, type the following:

**sw o2 off [Enter]**

3. To switch the next output to port 2, type the following:

**sw i02 + [Enter]**

The following tables show the possible values for commands:

Command	Description
sw	Switch command

Input Command	Description
i	Input command

Input Port Number	Description
xx	01-02 port (default is 01)

Output Command	Description
o	Output command

Output Port Number	Description
yy	01-02 port (default is 01)
*	All output ports

Control	Description
on	Turn on
off	Turn off
+	Next port
-	Previous port

- Note:**
1. Each command string can be separated with a space.
  2. The **Port Number** command string can be skipped, and the default value will be used.

The following table shows the available command list:

Cmd	In	N1	Out	N2	C2	Description
sw	i	xx	o	yy *		Switch Output Port xx to Input Port yy (xx:01~02, yy:01~02, *)
sw			o	yy *	on off	Turn on Output Port yy Turn off Output Port yy (yy:01~02, *)
sw			o	yy *	+ -	Switch Next Input to Output Port yy Switch Previous Input to Output Port yy (yy:01~02, *)

## READ COMMANDS

View information from the device using the following command:

### Read Command + [Enter]

The following tables show the possible values and formats for the **Control** command:

Command	Description
read	Reads and displays information from the VM0202H

The following table shows the available command list:

Command	Enter	Description
read	[Enter]	Displays information such as firmware version and EDID

## ECHO COMMANDS

If the Echo feature is enabled: for each action from the front panel (pushbuttons) or IR interface, the VM0202H sends a corresponding acknowledgment message to the attached controller or management device via the RS-232 port.

The formula for the Echo command is as follows:

### Echo Command + Control (on/off) +[Enter]

For example, to enable the Echo function, type the following:

### echo on [enter]

The following tables show the possible values for commands:

Command	Description
echo	Enable / Disable Echo function

Control	Description
on	Echo function on
off	Echo function off (default)

The following table shows the available command list:

Command	Control	Enter	Description
echo	on	[Enter]	Echo on
echo	off	[Enter]	Echo off

## CEC COMMANDS

Consumer Electronics Control (CEC) allows interconnected HDMI devices to communicate and respond to one remote control. The formula for CEC mode selection commands is as follows:

**CEC Command + Output Command + Port Number + Control (Off / On) [Enter]**

For example, to enable CEC function on output port 1, type the following:

**cec o01 on [enter]**

The following tables show the possible values for commands:

Command	Description
cec	CEC control

Output Command	Description
o	Output command

Port number	Description
yy	01-02 port (default is 01)
*	All output ports

Control	Description
off	Disable CEC (default)
on	Enable CEC

**Note:** Each command string can be separated with a space.

The following table shows the available command list:

Command	Output Command	Output Port	Control	Enter	Description
cec	o	yy *	off	[Enter]	CEC off for output port yy (default) (yy:01~02, *)
cec	o	yy *	on	[Enter]	CEC on for output port yy (yy:01~02, *)

## PANEL BUTTON CONTROL COMMANDS

The formula for Panel Button commands is as follows:

### Panel Button Command + Control + [Enter]

For example, to enable the front panel pushbuttons, type the following:

**button on [Enter]**

The following tables show the possible values for commands:

Command	Description
button	Front panel pushbutton enable/disable control

Command	Control	Description
button	on	Enable front panel pushbuttons (default)
button	off	disable front panel pushbuttons

The following table shows LED behavior under this command:

	Buttons Disabled	Buttons Enabled
All output on	LEDs flash twice, then LEDs on	LEDs light on, no flash
All output off	LEDs flash twice, then LEDs on	LEDs light on, no flash
Output on and Off	LEDs flash twice, then LEDs on	LEDs light on, no flash

## EDID MODE SELECTION COMMANDS

Extended Display Identification Data (EDID) is a data format that contains a display's basic information and is used to communicate with the video source/system. You can set which EDID mode the VM0202H uses with the following command:

### EDID Command + Control + [Enter]

For example, to pass the EDID from Port 1 to all sources, type the following:

### edid port1 [Enter]

The following tables show the possible values for commands:

Command	Control	Description
edid	port1	The EDID from Port 1 will be passed to all video sources
edid	remix	Implement the EDID of all connected displays. The VM0202H uses the best common resolution applicable for all displays
edid	default	Implement default EDID for all (default)

## RESET COMMANDS

The formula for Reset commands is as follows:

### Reset Command + [Enter]

For example, to reset the device back to the default factory settings, type the following:

### reset [Enter]

The following table shows the possible values for commands:

Command	Description
reset	Reset device back to factory default settings

## VERIFICATION

After entering a command, a verification message appears at the end of the command line as follows:

- ◆ **Command OK** - indicates that the command is correct and successfully performed by the switch
- ◆ **Command incorrect** - indicates that the command has the wrong format and/or values



## RS-232 PIN ASSIGNMENT

Pin	Description	Pin	Description
1	Not connected	6	Not connected
2	RXD	7	Not connected
3	TXD	8	Not connected
4	Not connected	9	Not connected
5	GND		

# SAFETY INSTRUCTIONS

## GENERAL

- ◆ Read all of these instructions. Save them for future reference.
- ◆ Follow all warnings and instructions marked on the device.
- ◆ This product is for indoor use only.
- ◆ Do not place the device on any unstable surface (cart, stand, table, etc.). If the device falls, serious damage will result.
- ◆ Do not use the device near water.
- ◆ Do not place the device near, or over, radiators or heat registers.
- ◆ The device cabinet is provided with slots and openings to allow for adequate ventilation. To ensure reliable operation, and to protect against overheating, these openings must never be blocked or covered.
- ◆ The device should never be placed on a soft surface (bed, sofa, rug, etc.) as this will block its ventilation openings. Likewise, the device should not be placed in a built in enclosure unless adequate ventilation has been provided.
- ◆ Never spill liquid of any kind on the device.
- ◆ Unplug the device from the wall outlet before cleaning. Do not use liquid or aerosol cleaners. Use a damp cloth for cleaning.
- ◆ The device should be operated from the type of power source indicated on the marking label. If you are not sure of the type of power available, consult your dealer or local power company.
- ◆ The device is designed for IT power distribution systems with 230V phase-to-phase voltage.
- ◆ To prevent damage to your installation it is important that all devices are properly grounded.
- ◆ The device is equipped with a DC adapter. This is a safety feature.
- ◆ To help protect your system from sudden, transient increases and decreases in electrical power, use a surge suppressor, line conditioner, or un-interruptible power supply (UPS).
- ◆ Position system cables and power cables carefully; Be sure that nothing rests on any cables.
- ◆ Never push objects of any kind into or through cabinet slots. They may touch dangerous voltage points or short out parts resulting in a risk of fire or electrical shock.
- ◆ Do not attempt to service the device yourself. Refer all servicing to qualified service personnel.
- ◆ If the following conditions occur, unplug the device from the wall outlet and bring it to qualified service personnel for repair.
  - ◆ Liquid has been spilled into the device.

- ◆ The device has been exposed to rain or water.
- ◆ The device has been dropped, or the cabinet has been damaged.
- ◆ The device exhibits a distinct change in performance, indicating a need for service.
- ◆ The device does not operate normally when the operating instructions are followed.
- ◆ Only adjust those controls that are covered in the operating instructions. Improper adjustment of other controls may result in damage that will require extensive work by a qualified technician to repair.

## **RACK MOUNTING**

- ◆ Before working on the rack, make sure that the stabilizers are secured to the rack, extended to the floor, and that the full weight of the rack rests on the floor. Install front and side stabilizers on a single rack or front stabilizers for joined multiple racks before working on the rack.
- ◆ Always load the rack from the bottom up, and load the heaviest item in the rack first.
- ◆ Make sure that the rack is level and stable before extending a device from the rack.
- ◆ Use caution when pressing the device rail release latches and sliding a device into or out of a rack; the slide rails can pinch your fingers.
- ◆ After a device is inserted into the rack, carefully extend the rail into a locking position, and then slide the device into the rack.
- ◆ Do not overload the AC supply branch circuit that provides power to the rack. The total rack load should not exceed 80 percent of the branch circuit rating.
- ◆ Make sure that all equipment used on the rack – including power strips and other electrical connectors – is properly grounded.
- ◆ Ensure that proper airflow is provided to devices in the rack.
- ◆ Ensure that the operating ambient temperature of the rack environment does not exceed the maximum ambient temperature specified for the equipment by the manufacturer.
- ◆ Do not step on or stand on any device when servicing other devices in a rack.

## SPECIFICATIONS

Function	VM0202H
<b>Video Input</b>	
Interface	2 x HDMI Type A Female (Black)
Impedance	100 Ω
Max Distance	1.8 m
<b>Video Output</b>	
Interface	2 x HDMI Type A Female (Black)
Impedance	100 Ω
Max Distance	15 m
<b>Video</b>	
Max Data Rate	10.2 Gbps (3.4 Gbps Per Lane)
Max Pixel Clock	340 MHz
Compliance	HDMI (3D, 4K, Deep Color) HDCP 1.4 Compatible Consumer Electronics Control (CEC)
Max Resolution	Up to 4096 x 2160 / 3840 x 2160 @ 60 Hz (4:2:0); 4096 x 2160 / 3840 x 2160 @ 30 Hz (4:4:4)
Max Distance	Up to 15 M
<b>Control</b>	
RS-232	Connector: 1 x DB-9 Female (Black) Baud Rate: 19200 Data Bits: 8, Stop Bits:1 Parity: No, Flow Control: No
USB	1 x Micro USB; F/W upgrade
IR	1 x Mini Stereo Jack Female (Black)

Function	VM0202H
<b>EDID Settings</b>	EDID Modes: Default / Port1 / Remix
<b>Power</b>	
Connectors	1 x DC Jack (Black)
Consumption	TBD
<b>Environmental</b>	
Operating Temperature	0 - 40° C
Storage Temperature	-20 - 60° C
Humidity	0 - 80% RH, Non-Condensing
<b>Physical Properties</b>	
Housing	Metal
Weight	TBD
Dimensions (L x W x H)	TBD

## LIMITED WARRANTY

IN NO EVENT SHALL THE DIRECT VENDOR'S LIABILITY EXCEED THE PRICE PAID FOR THE PRODUCT FROM THE DIRECT, INDIRECT, SPECIAL, INCIDENTAL OR CONSEQUENTIAL DAMAGES RESULTING FROM THE USE OF THE PRODUCT, DISK OR ITS DOCUMENTATION.

The direct vendor makes no warranty or representation, expressed, implied, or statutory with respect to the contents or use of this documentation, and specially disclaims its quality, performance, merchantability, or fitness for any particular purpose.

The direct vendor also reserves the right to revise or update the device or documentation without obligation to notify any individual or entity of such revisions, or update. For further inquires please contact your direct vendor.